

2016 Price Guide



WALDEN
PREMIER

NATURAL WOVEN MATERIALS REFERENCE A – R

PATTERN CODE	PATTERN NAME	PRICE GROUP	MAX. WIDTH	EDGE BINDING	SLIDING PANEL	FOLDING DOOR	MAXIMUM SIZE FOR MOTORIZED SHADES (SQARE FEET)	
							WITHOUT LINER	WITH LINER
E-432	Artisan Weave	D	96"	Y	N	N	44	38
E-416	Aspen Cedar	C	96"	Y	Y	Y	44	38
E-416-3	Aspen Ebony	C	96"	Y	Y	Y	44	38
E-082	Aspen Walnut	C	96"	Y	Y	Y	44	38
E-416-4	Aspen White	A	96"	Y	Y	Y	44	38
E-H33	Baja Walnut	C	96"	Y	Y	Y	64	56
E-R26	Bamboo Forest	B	96"	Y	Y	Y	44	38
E-365	Barcelona Café	B	96"	Y	Y	Y	54	44
E-363	Barcelona Dusk	B	96"	Y	Y	Y	54	44
E-006	Boardwalk	A	96"	Y	Y	Y	56	45
E-861	Bora Bora	B	96"	Y	Y	Y	50	42
E-405	Borneo Dappled	A	96"	Y	Y	Y	44	38
E-401	Cape Town	C	96"	Y	Y	Y	54	44
E-430	Capri Natural	C	96"	Y	Y	N	64	56
E-389	Catalina	D	96"	Y	Y	N	64	64
E-361	Devon Coffee	A	96"	Y	Y	Y	56	45
E-E11	Devon Ivory	A	96"	Y	Y	Y	56	45
E-E06	Devon Maple	A	96"	Y	Y	Y	56	45
E-E02	Devon White	A	96"	Y	Y	Y	56	45
E-022	Durban	A	96"	Y	Y	Y	56	45
E-L42	Fiji Earth	C	96"	N	N	N	56	45
E-L41	Fiji Olive	C	96"	N	N	N	56	45
E-R11	Island Spice	D	96"	Y	N	N	56	45
E-354	Jakarta Spice	C	96"	Y	Y	N	64	49
E-055	Java Cocoa	B	96"	Y	Y	Y	54	44
E-B01	Mandalay Umber	C	96"	Y	Y	Y	33	30
E-07M	Nassau Mahogany	D	96"	Y	Y	Y	33	30
E-390	Natural Jute	D	96"	Y	Y	N	64	56
E-C09	Osaka	B	96"	Y	Y	Y	56	45
E-378	Panama Sand	A	96"	Y	Y	Y	54	44
E-403-B	Penang Oak	A	96"	Y	Y	Y	56	45
E-043	Plaza Khaki	B	96"	Y	Y	Y	64	49
E-110	Plaza Mahogany	C	96"	Y	Y	Y	64	49
E-042	Plaza Tan	B	96"	Y	Y	Y	64	49
E-427	Prairie Golden	D	96"	Y	Y	N	64	56
E-828	Prairie Snow	D	96"	Y	Y	N	64	56
E-350	Prairie Sunset	C	96"	Y	Y	N	64	56
E-428	Prairie White	D	96"	Y	Y	N	64	56
E-034	Rangoon	B	96"	Y	Y	Y	56	45

NATURAL WOVEN MATERIALS REFERENCE S – W

PATTERN CODE	PATTERN NAME	PRICE GROUP	MAX. WIDTH	EDGE BINDING	SLIDING PANEL	FOLDING DOOR	MAXIMUM SIZE FOR MOTORIZED SHADES (SQUARE FEET)	
							WITHOUT LINER	WITH LINER
E-398	Sahara	B	96"	Y	Y	Y	54	44
E-001	Sakura Oregano	C	96"	Y	Y	N	54	44
E-352	Savanna Husk	C	96"	Y	Y	N	64	56
E-030	Sedona	C	96"	Y	Y	Y	64	49
E-040	Shoji	B	96"	Y	Y	Y	56	45
E-369	Sierra Cinnamon	D	96"	Y	N	N	50	42
E-367	Sierra Olive	D	96"	Y	N	N	50	42
E-370	Sierra Sand	D	96"	Y	N	N	50	42
E-381	Split Bamboo	A	96"	Y	Y	Y	44	38
E-438	Sunshade Brown	A	96"	Y	Y	Y	54	48
E-10H	Sunshade White	C	96"	Y	Y	Y	44	38
E-394	Tamarind Sunset	B	96"	Y	Y	Y	44	38
E-372	Tradewind Natural	D	96"	Y	Y	N	56	45
E-383	Water Reeds	B	96"	N	N	N	50	42
E-011-2	Woodweave Brown	D	96"	Y	Y	Y	54	44
E-011	Woodweave Espresso	D	96"	Y	Y	Y	54	44

COLOR REFERENCE

EDGE BINDINGS

COLOR	COLOR NUMBER	WIDTH	COLOR	COLOR NUMBER	WIDTH
WIDE WIDTH BINDING			NARROW WIDTH BINDING		
Beige	W3	3"	Beige	T3	1"
Black	W10	3"	Black	T10	1"
Chocolate	W4	3"	Chocolate	T4	1"
Copper	W5	3"	Copper	T5	1"
Cream	W8	3"	Cream	T8	1"
Desert Sand	W6	3"	Desert Sand	T6	1"
Light Beige	W2	3"	Light Beige	T2	1"
Natural	W15	3"	Natural	T15	1"
Sienna	W11	3"	Sienna	T11	1"
White	W1	3"	White	T1	1"

LINERS

COLOR NUMBER	COLOR	MATERIAL	WIDTH
PRIVACY LINERS			
W4-L	Privacy White	80% Polyester/20% Cotton	55"
NK-L	Privacy Beige	80% Polyester/20% Cotton	55"
NC-L	Privacy Chocolate	80% Polyester/20% Cotton	55"
BLACK-OUT LINERS			
W4-D	Black-Out White	80% Polyester/20% Cotton	55"
K3-D	Black-Out Beige	80% Polyester/20% Cotton	55"
C2-D	Black-Out Chocolate	80% Polyester/20% Cotton	55"

Privacy Liners are the same color both sides.

Black-Out Liners are white to the street.

SHADE STYLES

All standard shade styles operate with a cord lock and are supplied with cord cleats to keep the cords tidy and away from children or pets.

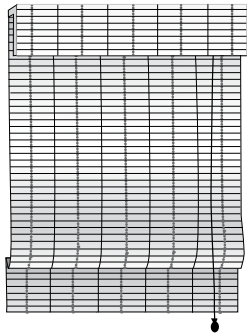
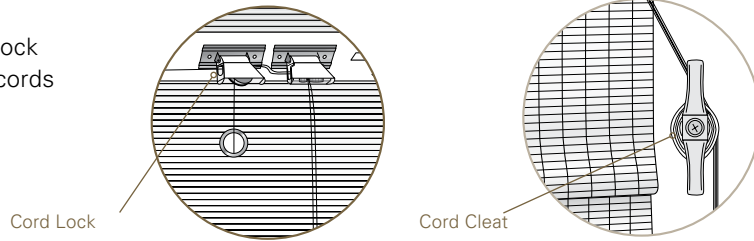

STANDARD ROMAN SHADE

Shade is raised by means of cords, which hang in front of the shade. Includes a 6-inch valance to conceal the components. When raised, the material rises from the bottom in flat folds.

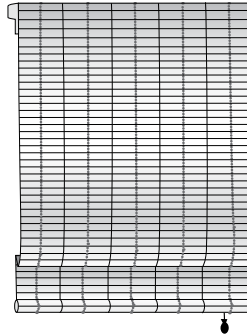

WATERFALL SHADE

Shade is raised by means of cords, which hang behind the shade. Material is attached to the front of the head rail, without a valance. When raised, the material rises from the bottom in flat folds.

Optional back valance is available on request.

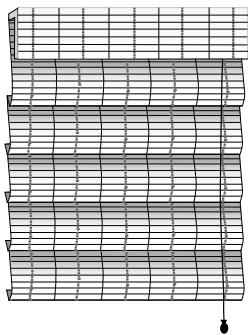

HOBBLED SHADE

Shade is constructed the same way as a Standard Shade, with a 6" valance and cords in front of the shade. When lowered, the shade maintains its folds, giving it a soft fabric look.

NOTE that Hobbled shades contain more material and are heavier than the Standard Roman and Waterfall shades.

VALANCES AND VALANCE RETURNS

Valance returns supplied with all outside mount shades. They also are available on request with inside mount shades.

Standard valance returns are 6" long and are made of the bamboo pattern chosen.

Short valance returns (2" long) are available on request. Short returns conceal the end of the headrail and components and remain clear of the shade when it is fully raised.

FABRIC VALANCE RETURNS

For shades with edge binding, returns made from the edge binding fabric are available as a surcharge option.

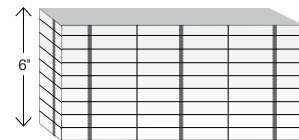

6" standard valance return

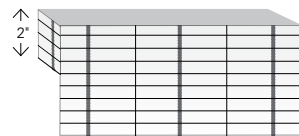

2" short valance return

SHADE OPTIONS

LINERS

Liners can be ordered attached to the back of the shade or as a separately operable, movable liner (Twin Shade below).

ATTACHED LINERS

Available in Privacy or Black-Out liner. Liners are secured to the back of the shade by stitches at each side of the liner.

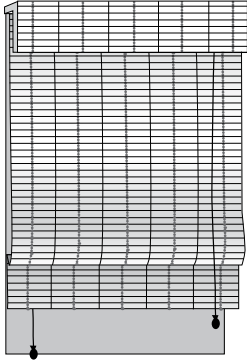

TWIN SHADE

Features two separate, independently operated shades on one head rail. The front shade can be either a standard or waterfall natural woven shade.

A separate liner shade is attached to the back of the head rail and both shades operate independently. Lift cords can be on the same side or opposite sides of the shade.

Available with Roll Ease® clutch control for the front, natural woven shade or for both shades.

See Specifications for head rail sizes.

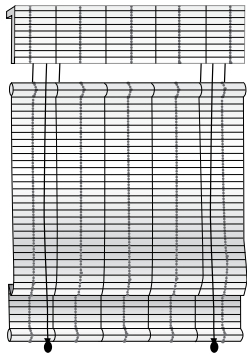

TOP DOWN BOTTOM UP SHADES

Shades can be raised from the bottom or lowered from the top by two sets of cords on opposite sides of the shade. Includes a 6" valance to conceal the components. Available with liners and edge binding.

All Top Down Bottom Up shades will be supplied with lined valances to conceal the components and any light gap that may be visible at the top of the shade. This is included in the Top Down Bottom Up surcharge.

Top Down Bottom Up shades are only available to 84" wide.

MULTIPLE SHADES ON ONE HEAD RAIL

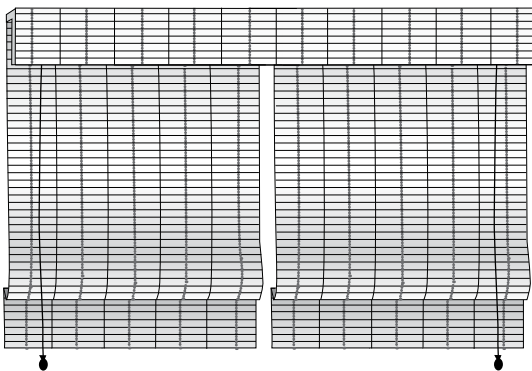

Shades can be ordered two-on-one head rail, or three-on-one head rail, up to a maximum width of 120 inches. The width limit for a common valance is 96 inches. Not available with cordless or top down bottom up.

Normal inside mount deductions will be made and there will be a maximum ½ inch gap between shades.

CONTROL OPTIONS

CLUTCH CONTROL AND CONTINUOUS CORD LOOP

Clutch controls are available with all shade styles, but not with Top Down Bottom Up. All clutch control shades come with cord tensioners, which should be securely fixed to the wall to allow for the shade to operate freely and to keep dangerous hanging loops away from children and pets.

Cord loops are available in one foot increments from 2 feet to 8 feet. The factory will choose the length closest to 2/3rds the height of the shade, unless otherwise requested.

Metal bead chain is also available and can be made to custom lengths. Unless requested, the loop will be 2/3rds the height of the shade.

Shades with clutch controls will be mounted on a wider head rail (see Specifications for details).

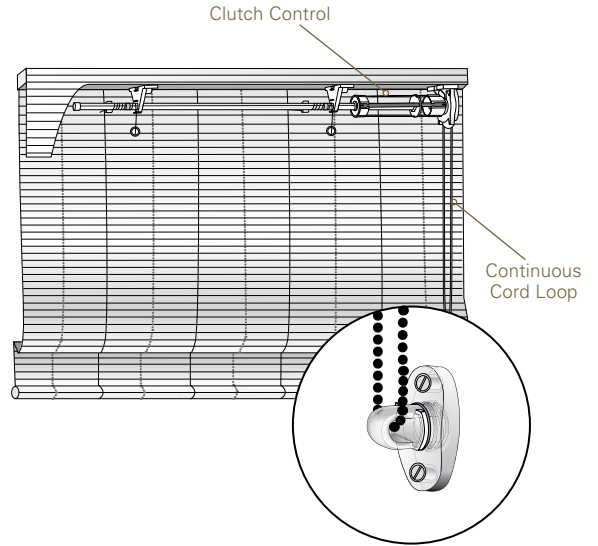

Cord Tensioner and Bracket

CORDLESS SHADES

Cordless shades operate with no lift cords on the front of the shade. The shade is lowered by pulling on a tassel located at the back of the shade and raised by lifting up the bottom bar. A spring control system, located under the wood head rail, holds the shade in place in the desired position.

The cordless option is not available with Top Down Bottom Up.

Cordless shades are available up to 72" wide and 72" long and will be mounted on a wider head rail (see Specifications for details).

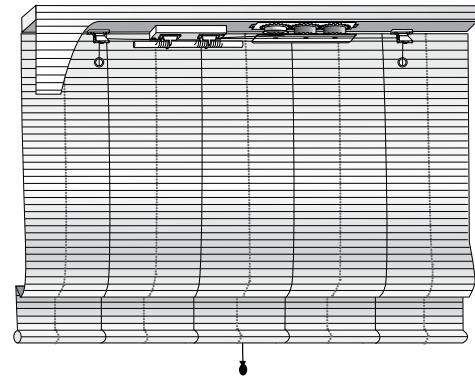

Cordless Shade

MOTORIZED SHADES

Motor control shades are operated by a lithium-ion internal battery motor, which is operated by either a single channel or a multi-channel radio frequency remote control. The single channel remote can operate up to 20 shades in one group, with a range of about 100 feet. The multi-channel remote has 15 channels.

The motor battery is recharged using an AC power adaptor, which plugs into a port in the head of the motor.

Check the specifications for the maximum sizes of shades, which can be operated by this battery motor. Motorized shades will be mounted on a wider head rail (see Specifications for details).

AC Motors can be specified for larger shades. Please call us for specifications and quotes.

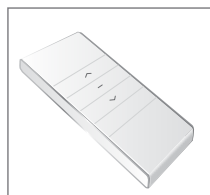

Remote Control

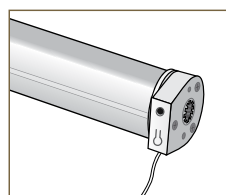

Port in the Head of the Motor

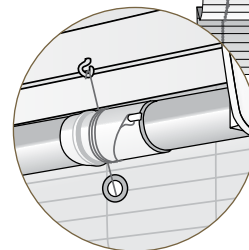

Motor Control Shade

CONTROL OPTIONS

WAND CONTROL SHADES

Wand control shades are operated by the same lithium-ion battery motor as motorized shades. The motor is controlled using a wand, which hangs down to the side of the shade.

Wands are available in 4 lengths: 24", 36", 48" and 60" and in five colors: white, beige, gray, black and bronze.

Wand motors are recharged via a mini USB power adaptor, which plugs into the end of the wand.

Check the specifications for the maximum sizes of shades, which can be operated by this battery motor.

The head rail and valance for Outside Mount wand control shades will be made with an extra 5/8" of width on the control side, so that the wand can hang beside the shade.

Inside mount wand control shades will be made with the standard 3/8" IB deduction and then the shade fabric will be cut 5/8" narrower on the control side to allow the wand to hang to the side of the shade. This may cause a light gap on black out shades.

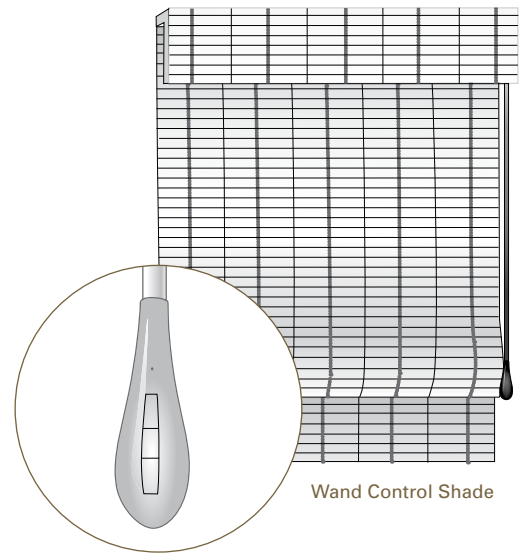

Wand Control Shade

OTHER OPTIONS

LINED VALANCE

Lined Valances are recommended to conceal the head rail components where an open-weave pattern is selected.

All Top Down Bottom Up Shades are made with lined valances as standard.

EDGE BINDINGS

Available in 2 widths: 1" (1/2" on the face of the shade) and 3" (1 1/2" on the face of the shade).

Narrow edge binding is applied to the sides of the shade and the valance.

Wide edge binding is applied to the sides of the shade and the valance and also to the bottom of the shade.

Wide edge binding not available with hold down brackets.

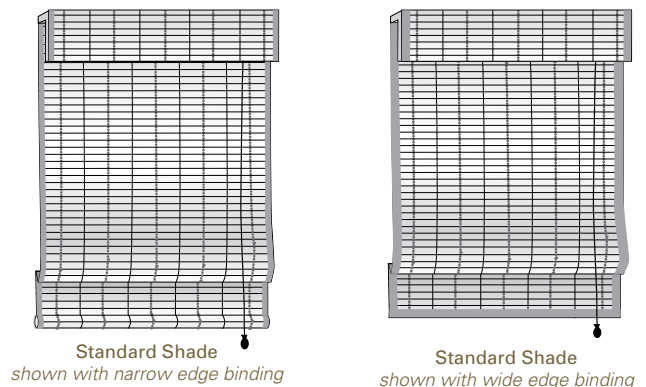

Standard Shade
shown with narrow edge binding

Standard Shade
shown with wide edge binding

CUT OUTS

Cut Outs can be taken from either side of the shade. Please provide exact dimensions and the locations of cut outs required.

There may be limitations to what can be cut out, based upon the size and specifications of the shade. The factory will review all orders for cut outs and provide confirmation of each order within 24 hours.

Cut Outs are not available with edge binding.

FABRIC WRAPPED HEAD RAIL

Standard shades come with a stained wood head rail. Fabric wrapped head rails are a decorative option, where the head rail is covered with the same woven wood material as the shade.

BRACKETS AND SPACER BLOCKS

Hold down brackets supplied upon request (not available with wide edge binding).

Spacer blocks are available upon request.

SHADE SPECIFICATIONS

SIZE LIMITATIONS

Minimum Width: 12" Minimum Height: 18"
Maximum Width: 96" Maximum Height: 108"

Minimum Width Roll Ease Clutch: 18"

Maximum Width Top Down Bottom Up: 84"

Minimum Width Cordless: 18"

Minimum Width Motorized: 20"

Minimum Width Wand Control: 20"

Maximum Width and Height Cordless: 72"

Multiple shades on one head rail can be ordered to 120 inches wide. Maximum width for common valance is 96 inches.

BRACKET DIMENSIONS

Height: 1 1/2"
Depth: 1 3/4"

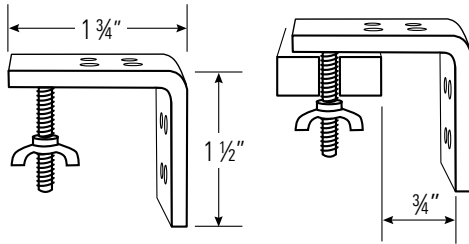

INSIDE MOUNT DEPTHS

Minimum Required Depth: 3/4" with standard bracket

Flush Mount Depth: Head rail width plus 1" if using standard bracket.

Exact flush inside mount depths will vary slightly based upon the thickness of the fabric.

INSIDE MOUNT DEDUCTIONS

The factory will make a deduction of 3/8 inch for all Inside Mount shades, unless otherwise requested.

RING SPACING AND STACK HEIGHT

Rings are spaced 7" apart on the back of the shade. The stacking height will be approximately 8" - 10" for all heights of shades.

WAND CONTROL SHADES

All wand control shades are made with the valance and head rail 5/8" wider than the shade, to allow the wand to hang to the side of the shade.

OUTSIDE MOUNT

The shade will be made at the ordered width, the head rail and valance will be 5/8" wider on the control side.

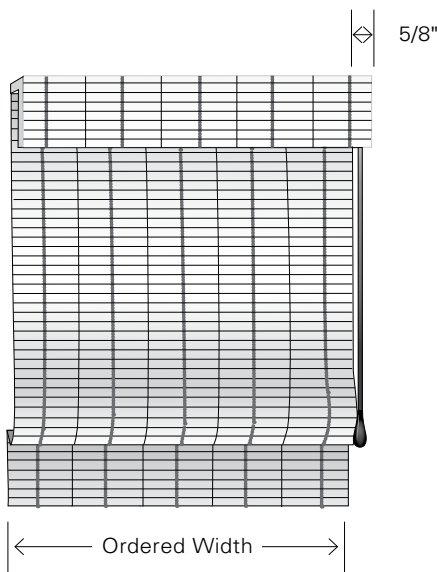

INSIDE MOUNT

The shade, head rail and valance will be made with a 3/8" IB deduction.

The shade will be cut an extra 5/8" narrower on control side.

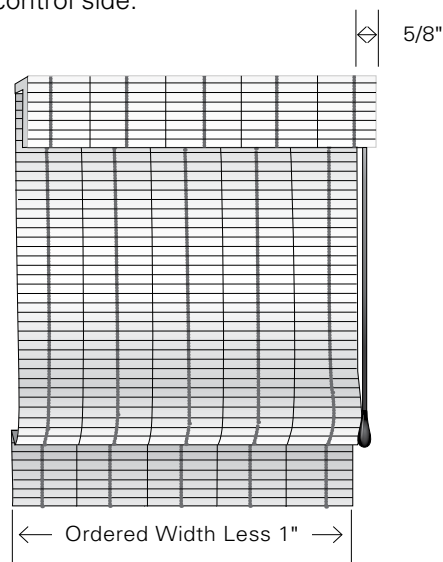

SHADE SPECIFICATIONS

HEAD RAIL DIMENSIONS

Middle support brackets will be supplied for all shades over 41 inches wide.

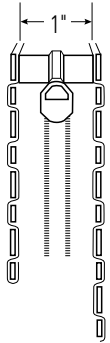

NARROW HEAD RAIL
(Custom Order Only)

- Standard Shades
- Waterfall Shades
- TDBU Shades

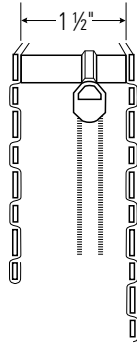

STANDARD HEAD RAIL

- Standard Shades
- Waterfall Shades
- TDBU Shades

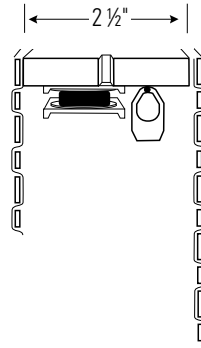

CORDLESS HEAD RAIL

- Standard Shades
- Waterfall Shades

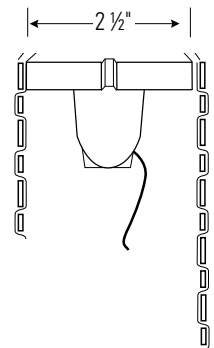

**MOTORIZED HEAD RAIL
REMOTE OR WAND CONTROL**

- Standard Shades
- Waterfall Shades

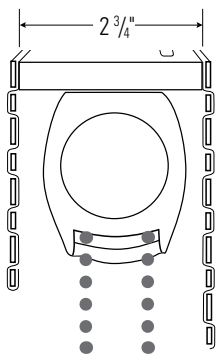

CLUTCH SHADE
with Continuous Cord Loop (shown)

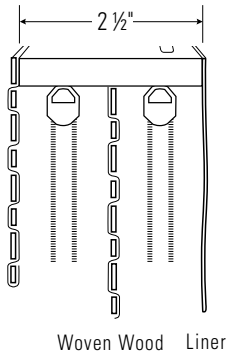

STANDARD TWIN SHADE
*Controls Same Side (shown)
or Opposite Sides*

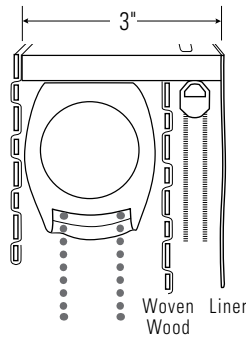

TWIN SHADE WITH CLUTCH
*(Clutch Control for
Front Shade Only)
Controls Same Side (shown)
or Opposite Sides*

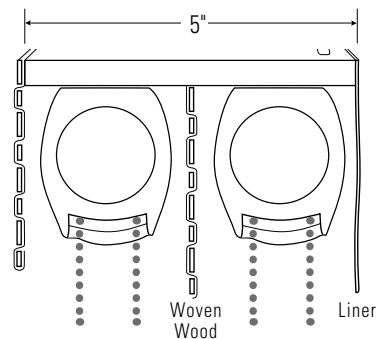

TWIN SHADE WITH 2 CLUTCHES
*Controls Same Side (shown)
or Opposite Sides*

FOLDING DOORS

Folding doors are ideal for large windows or doors and hang vertically from hangers, which slide smoothly inside an aluminum track. On each side of the door are bamboo bars with handles, if desired. The bamboo wood bars are a natural "carbon" color, which is a natural, light wood tone that coordinates well with all patterns. All folding doors are provided with brown track. White track can be supplied on request.

Check the Material Reference Chart for which patterns are available to be made as Folding Doors.

Folding doors come in one of two configurations: One Way Opening or Center Opening.

ONE WAY OPENING

When open, the material stacks back either to the right or the left. Specify on the Order Form which side of the door the drapery will stack to.

NOTE: If you want the material to stack back completely clear of the window, for an unobstructed view when the door is open, allow for the width of the stack in the overall width of the door.

CENTER OPENING (SPLIT DRAW)

The door is made from two panels, which are equal width and meet in the middle. They open to opposite sides of the window.

Each panel has a bamboo wood bar on each side and the two middle bars have small, countersunk magnets which hold the two bars together tightly, when the panels are in the closed position.

DRAPER Y STYLE

Folding Doors can be ordered "Drapery Style", with no edge bars and with edge binding on four sides of the panel. This gives a softer look to the shade.

Drapery Style Folding Doors can also be ordered one way or center opening.

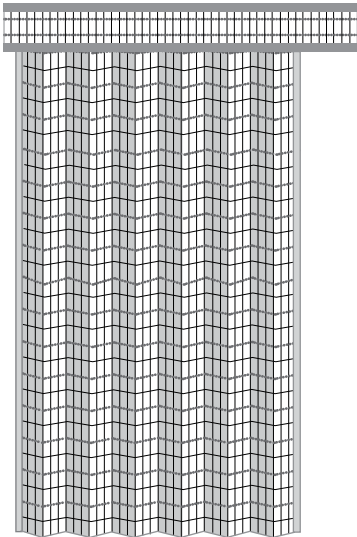

One-Way Left Stack
shown with valance

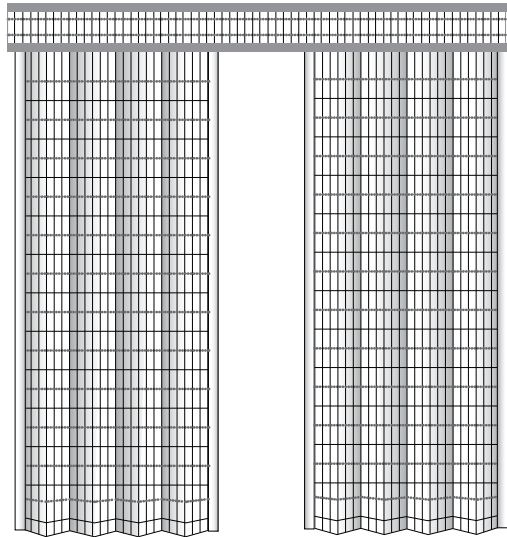

Center Opening - Split Draw
shown with valance

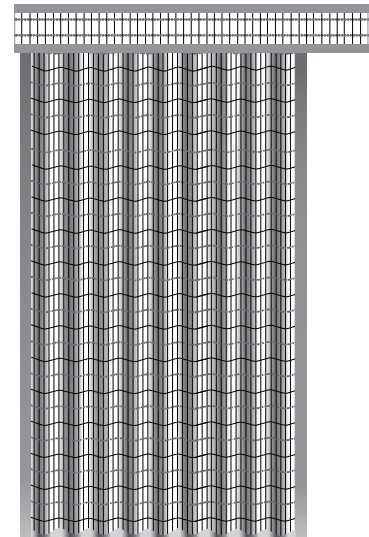

Drapery Style Left Stack
shown with valance

FOLDING DOOR OPTIONS

FULLNESS

The standard folding door comes with 5% fullness, which means that it lies nearly flat when fully extended.

Folding doors can be ordered with 20% fullness, which gives fuller folds.

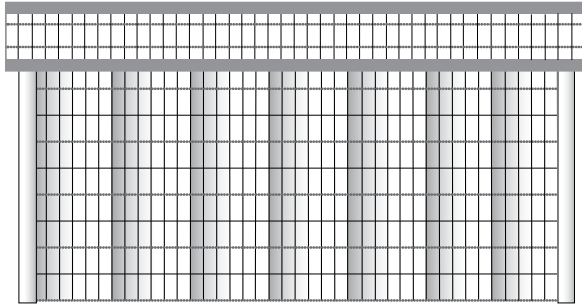

5% fullness
shown with valance

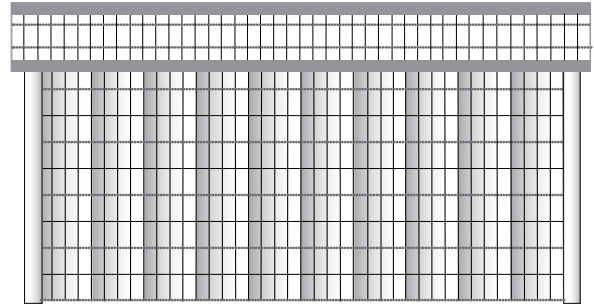

20% fullness
shown with valance

LINERS

Available in Privacy or Black-Out Liner. Liners are attached to the top of the folding door and are secured down both sides beneath the bamboo wood bars.

VALANCE

Standard folding doors come with track and panels. Adding a valance provides a decorative touch, which conceals the track and hangers and blocks any light gap between the track and the top of the door.

The valance is 8 inches long and is mounted to a wood board, 5 1/2" deep and 3/4" thick. The valance is attached to the front edge of the board by velcro.

The valance is oriented in the same direction as the door (vertically) and is edge-bound on the top and the bottom.

For Inside Mount shades, the valance will cover the front of the valance board only. For Outside Mount shades, the valance will be made to wrap around both ends of the valance board.

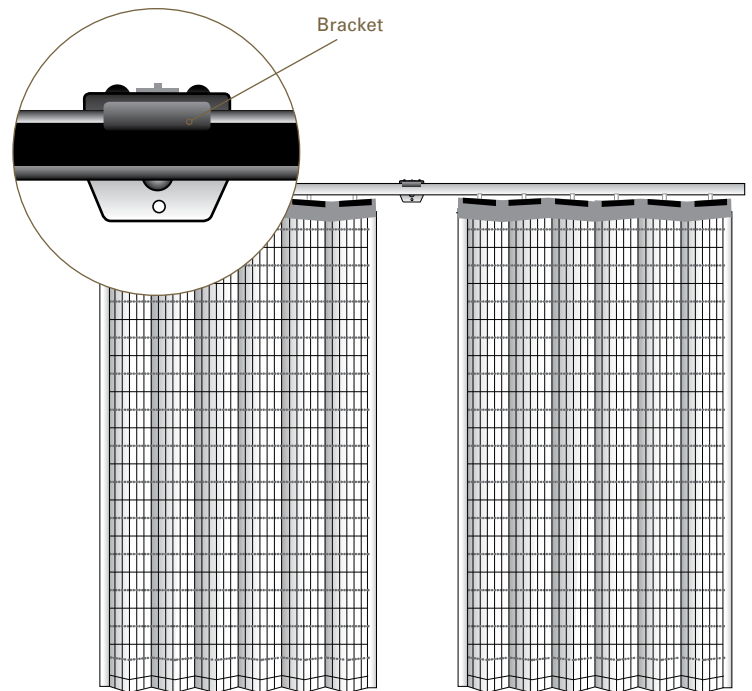

Center Opening – Split Draw
shown without valance

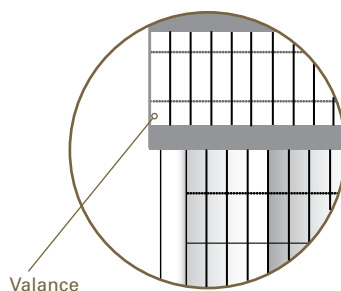

FOLDING DOOR SPECIFICATIONS

SIZE LIMITATIONS

Minimum Width: 24 inches
 Maximum Width: 192 inches
 Minimum Height: 24 inches
 Maximum Height: 96 inches

Tracks and valance boards wider than 100" will be spliced to reduce shipping charges.

IMPORTANT INFORMATION FOR ORDERING AND INSTALLING FOLDING DOORS

DOORS WITHOUT A VALANCE

For doors without a valance, the height of the folding door is measured from the top of the track to the bottom of the fabric.

There is a gap of approximately 3/4" between the top of the track and the material. The factory will deduct this amount from the ordered length when they make the fabric panel.

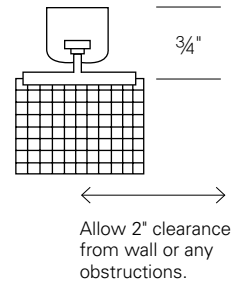

DOORS WITH A VALANCE

For doors with a valance, the height of the folding door is measured from the top of the valance board to the bottom of the fabric.

The valance board is 3/4" thick and there is 3/4" between the top of the track and the top of the material. The factory will deduct 1 1/2" from the ordered length when they make the fabric panel.

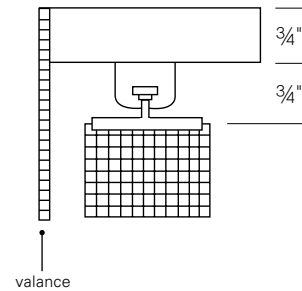

INSIDE MOUNT MEASUREMENTS

Minimum Inside Mount Depth: 2 inches

Check for any obstructions, such as trim or handles that may interfere with the opening and closing of the door.

Inside Mount Deductions:

Width: 1/4"
 Height: 3/4"

No deductions are made to the width or height of Outside Mount doors.

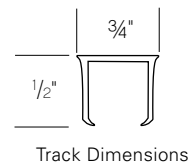
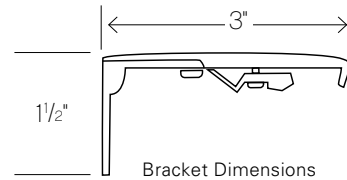

STACKING CHART

WIDTH	STACK
36"	8 1/2"
42"	9"
48"	9 1/2"
60"	11"
72"	12"
84"	13"
96"	14"

Center Opening shades will open into two equal stacks on each side of the shade. For example a 96" Center Opening will have two stacks each the size of a 48" One Way.

20% Fullness shades will stack approximately 1 inch wider for small shades and 1 1/2 inches wider for larger shades, than a 5% Fullness shade of the same size.

All stacking dimensions are approximate and will vary by pattern.

SLIDING PANELS

Sliding panels provide a clean, contemporary look for large windows and doors. Overlapping panels are suspended from hangers, which glide smoothly in an aluminum track and pass in front of each other, to allow the panels to stack back away from the window.

The panels are supplied with edge binding to protect them from wear and tear and the panels are customized-sized, based on the width of the shade and the number of panels. Panels can be made with privacy or black-out liners.

Sliding panels can be one way draw or center opening and are operated by means of a wood wand. Center opening shades will have two wands.

Cord-draw sliding panels are not available.

NOTE: Bamboo and natural materials can stretch or shrink, so we recommend that panels are ordered with at least $\frac{3}{4}$ " clearance from the ground. Also, when shipped from the factory, panels may be slightly different lengths (up to $\frac{1}{2}$ " from the ordered length). Shorter panels can be made longer by gently pulling on the bottom of the panel until they are the same length as longer panels.

NO CHARGE OPTIONS

ONE WAY OPENING

When open the panels stack back to either the right or the left. Specify on the order form which side of the window the panels will stack to.

NOTE: If you want the material to stack completely away from the window, for an unobstructed view, allow for the width of the panels in the overall width of the shade. See "Specifications" for more details.

The standard configuration is for the front panel to be stationary and for the other panels to stack behind it.

Reverse stacking is available upon request, with the rear panel stationary.

Free-floating panels are also available.

CENTER OPENING

Must be made with an even number of panels and the panels will stack back to both sides.

The standard configuration is for the front panels to be stationary and for the other panels to stack behind them.

Reverse stacking is available upon request, with the rear panels stationary.

Free-floating panels are also available.

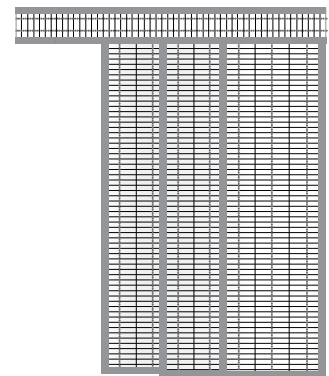

One-Way Right Stacked

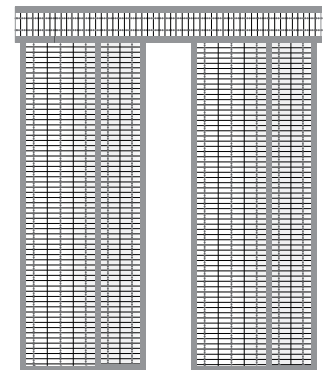

Center Opening

SLIDING PANEL SURCHARGE OPTIONS

LINERS

Available in Privacy or Black Out. Liners are sewn under the edge bindings on all four sides of the panels.

VALANCE

Valances are 8" long and are attached to the front and sides of the track by velcro. If ordered with the original shade, the velcro for the valance will be riveted to the front of the track, to ensure a lasting bond.

Valances are cut up the roll, so they wrap around the ends of the track. Valance returns are not required. For Inside Mount shades the valance will cover the front of the track only. For Outside Mount shades the valance will be made to wrap around both ends of the track. This means the valance material is rail-roaded and will be oriented differently to the panels.

If valances are ordered separately, both halves of the velcro will be provided, but the bond between the velcro and the track will not be as durable.

WIDE EDGE BINDING

Panels will come with narrow (1 inch) edge binding as standard, which means that $\frac{1}{2}$ inch is visible on the face of the panels. Wide (3 inch) edge binding is also available in the same colors.

SLIDING PANEL SPECIFICATIONS

SIZE LIMITATIONS

Minimum Width: 48" Minimum Height: 24"
 Maximum Width: 144" Maximum Height: 108"

Tracks wider than 100 inches will be spliced to avoid shipping charges.

STANDARD PANEL CONFIGURATIONS

WIDTH	TYPE OF OPENING	NUMBER OF PANELS	TRACK TYPE
48" – 84"	One Way	3 Panels	3 Channel
	Center Opening	4 Panels	4 Channel
84 ¼" – 120"	One Way	4 Panels	4 Channel
	Center Opening	4 Panels	4 Channel
120 ¼" – 144"	One Way	5 Panels	5 Channel
	Center Opening	6 Panels	3 Channel

TYPICAL PANEL SIZES (OUTSIDE MOUNT SHADES)

WIDTH	ONE WAY DRAW		CENTER OPENING	
	Number of Panels	Panel Width	Number of Panels	Panel Width
60"	3 panels	22 ¼"	4 panels	17 ¾"
72"	3 panels	26 ¼"	4 panels	20 ¾"
84"	3 panels	30 ¼"	4 panels	23 ¾"
96"	4 panels	26 ¾"	4 panels	26 ¾"
108"	4 panels	29 ¾"	4 panels	29 ¾"
120"	4 panels	32 ¾"	4 panels	32 ¾"
132"	5 panels	28 ¾"	6 panels	24 ¾"
144"	5 panels	31 ⅛"	6 panels	26 ¾"

PANEL SIZE CALCULATIONS

Inside Mount: Deduct 1 ⅛" from the width. Divide by the number of panels and add 2 ½" for the overlap. Round up to the nearest ⅛".

Outside Mount: Deduct 7/8" from the width. Divide by the number of panels and add 2 ½" for the overlap. Round up to the nearest ⅛".

TRACK DIMENSIONS

TRACK DEPTHS	
3 Channel	2"
4 Channel	2 ¾"
5 Channel	3 ⅜"

The distance from the top of the track to the top of the panels is 1 inch. The factory will take account of this distance when calculating the panel length.

MOUNTING DEPTHS

	3 TRACK	4 TRACK	5 TRACK
Minimum IB	2"	2 ¾"	3 ⅜"
Flush IB	2 ½"	3 ¼"	3 7/8"

Wall or Face Mount: 2 7/8" flat mounting surface required. (Using L Bracket)

INSIDE MOUNT DEDUCTIONS

IB Deduction (Width): ¼"
 IB Deduction (Height): ½"

DISTANCE FROM THE WALL TO THE BACK OF THE TRACK

	3 CHANNEL TRACK	4 CHANNEL TRACK	5 CHANNEL TRACK
Standard Bracket (2 7/8")	1 ¾"	1 ¼"	¾"
Large Bracket (4 ¼")	2 ½"	2 ¾"	1 7/8"

Adding an extension bracket will provide an extra 2 7/8" of clearance from the wall.

Add the track depth to the clearance to calculate the total projection into the room.

ROMAN SHADE PRICING

Includes Standard Roman Shade and Waterfall Shades.

WIDTH

PRICE GROUP A		WIDTH								
		24"	30"	36"	42"	48"	60"	72"	84"	96"
LENGTH	36"	\$126	\$130	\$158	\$175	\$194	\$238	\$268	\$311	\$341
	48"	\$144	\$165	\$185	\$209	\$230	\$286	\$319	\$373	\$411
	54"	\$153	\$185	\$200	\$223	\$251	\$310	\$352	\$402	\$447
	60"	\$162	\$192	\$215	\$238	\$261	\$330	\$385	\$432	\$484
	66"	\$170	\$200	\$230	\$254	\$281	\$376	\$414	\$476	\$534
	72"	\$179	\$211	\$245	\$271	\$298	\$393	\$436	\$521	\$584
	78"	\$190	\$225	\$259	\$292	\$324	\$417	\$471	\$551	\$621
	84"	\$201	\$238	\$275	\$311	\$352	\$441	\$497	\$584	\$665
	96"	\$219	\$263	\$306	\$345	\$385	\$502	\$574	\$669	\$761
	108"	\$247	\$295	\$343	\$389	\$433	\$564	\$645	\$752	\$856

PRICE GROUP B		WIDTH								
		24"	30"	36"	42"	48"	60"	72"	84"	96"
LENGTH	36"	\$152	\$168	\$196	\$213	\$230	\$268	\$305	\$357	\$405
	48"	\$184	\$211	\$238	\$261	\$285	\$323	\$364	\$432	\$504
	54"	\$191	\$223	\$253	\$279	\$305	\$350	\$395	\$468	\$541
	60"	\$201	\$234	\$268	\$296	\$323	\$376	\$425	\$504	\$578
	66"	\$211	\$248	\$284	\$314	\$344	\$401	\$457	\$538	\$613
	72"	\$222	\$260	\$299	\$332	\$364	\$425	\$488	\$571	\$648
	78"	\$231	\$273	\$315	\$351	\$385	\$452	\$519	\$604	\$686
	84"	\$240	\$286	\$330	\$368	\$405	\$478	\$549	\$636	\$722
	96"	\$263	\$326	\$360	\$403	\$445	\$551	\$637	\$734	\$827
	108"	\$295	\$351	\$404	\$453	\$500	\$620	\$716	\$825	\$929

PRICE GROUP C		WIDTH								
		24"	30"	36"	42"	48"	60"	72"	84"	96"
LENGTH	36"	\$176	\$200	\$225	\$239	\$268	\$332	\$387	\$473	\$545
	48"	\$195	\$227	\$258	\$278	\$298	\$384	\$448	\$543	\$642
	54"	\$208	\$243	\$277	\$300	\$322	\$406	\$491	\$591	\$677
	60"	\$222	\$258	\$294	\$320	\$352	\$442	\$519	\$621	\$729
	66"	\$235	\$273	\$311	\$338	\$377	\$478	\$563	\$671	\$780
	72"	\$247	\$288	\$328	\$357	\$398	\$520	\$611	\$728	\$843
	78"	\$260	\$303	\$347	\$384	\$433	\$550	\$646	\$770	\$894
	84"	\$272	\$318	\$364	\$412	\$458	\$580	\$681	\$811	\$943
	96"	\$296	\$349	\$399	\$450	\$510	\$658	\$783	\$920	\$1,059
	108"	\$334	\$393	\$448	\$507	\$574	\$741	\$881	\$1,034	\$1,192

PRICE GROUP D		WIDTH								
		24"	30"	36"	42"	48"	60"	72"	84"	96"
LENGTH	36"	\$205	\$215	\$243	\$259	\$275	\$350	\$408	\$496	\$585
	48"	\$213	\$242	\$280	\$302	\$324	\$412	\$483	\$582	\$680
	54"	\$227	\$268	\$309	\$329	\$349	\$441	\$520	\$624	\$730
	60"	\$239	\$289	\$327	\$354	\$372	\$470	\$557	\$667	\$778
	66"	\$253	\$300	\$347	\$371	\$396	\$538	\$618	\$729	\$848
	72"	\$268	\$311	\$355	\$389	\$421	\$565	\$665	\$791	\$917
	78"	\$278	\$327	\$374	\$444	\$458	\$596	\$702	\$836	\$969
	84"	\$294	\$343	\$393	\$469	\$495	\$629	\$740	\$878	\$1,023
	96"	\$322	\$378	\$433	\$475	\$544	\$728	\$856	\$1,016	\$1,176
	108"	\$362	\$425	\$487	\$534	\$611	\$818	\$963	\$1,143	\$1,323

ROMAN SHADE SURCHARGE OPTION PRICING

Add the surcharge below to the retail price for the basic shade.

WIDTH

		24"	30"	36"	42"	48"	60"	72"	84"	96"	
PRIVACY LINER Privacy White Privacy Beige Privacy Chocolate Privacy Liners are the same color both sides	LENGTH	36"	\$25	\$32	\$38	\$44	\$51	\$63	\$76	\$89	\$102
		48"	\$33	\$41	\$49	\$57	\$65	\$82	\$98	\$114	\$131
		54"	\$36	\$45	\$54	\$63	\$73	\$91	\$109	\$127	\$145
		60"	\$40	\$50	\$60	\$70	\$80	\$100	\$120	\$140	\$160
		66"	\$44	\$54	\$65	\$76	\$87	\$109	\$131	\$152	\$174
		72"	\$47	\$59	\$71	\$83	\$94	\$118	\$141	\$165	\$189
		78"	\$51	\$63	\$76	\$89	\$102	\$127	\$152	\$178	\$203
		84"	\$54	\$68	\$82	\$95	\$109	\$136	\$163	\$190	\$218
		96"	\$62	\$77	\$93	\$108	\$123	\$154	\$185	\$216	\$247
		108"	\$69	\$86	\$103	\$121	\$138	\$172	\$207	\$241	\$276

		24"	30"	36"	42"	48"	60"	72"	84"	96"	
BLACK-OUT LINER Black-Out White Black-Out Beige Black-Out Chocolate Black-Out Liners are white to the street	LENGTH	36"	\$27	\$33	\$40	\$47	\$53	\$67	\$80	\$93	\$107
		48"	\$34	\$43	\$51	\$60	\$69	\$86	\$103	\$120	\$137
		54"	\$38	\$48	\$57	\$67	\$76	\$95	\$114	\$133	\$153
		60"	\$42	\$52	\$63	\$73	\$84	\$105	\$126	\$147	\$168
		66"	\$46	\$57	\$69	\$80	\$92	\$114	\$137	\$160	\$183
		72"	\$50	\$62	\$74	\$87	\$99	\$124	\$149	\$174	\$198
		78"	\$53	\$67	\$80	\$93	\$107	\$133	\$160	\$187	\$214
		84"	\$57	\$72	\$86	\$100	\$114	\$143	\$172	\$200	\$229
		96"	\$65	\$81	\$97	\$113	\$130	\$162	\$195	\$227	\$259
		108"	\$72	\$91	\$109	\$127	\$145	\$181	\$217	\$254	\$290

TOP DOWN BOTTOM UP: **\$45**

HOBBLED STYLE: **30%**

TWIN SHADE: **\$120 plus liner surcharge**

CORDLESS SHADE:
 UP TO 42": **\$140**
 48" and ABOVE: **\$185**

WAND MOTOR: **\$210**

MOTORIZED: **\$370**

SINGLE-CHANNEL REMOTE: **\$45**

MULTI-CHANNEL REMOTE: **\$70**

CUT OUTS: **\$30 per cut out**

2-ON-1 HEAD RAIL: **\$40. Price as individual shades and add surcharge.**

3-ON-1 HEAD RAIL: **\$50. Price as individual shades and add surcharges.**

FABRIC VALANCE RETURNS: **\$30**

OPTIONAL LINED VALANCE: **\$15**

	24"	30"	36"	42"	48"	60"	72"	84"	96"
ROLL EASE CLUTCH SYSTEM	\$90	\$105	\$120	\$130	\$135	\$140	\$150	\$160	\$170

ROMAN SHADE SURCHARGE OPTION PRICING

Add the surcharge below to the retail price for the basic shade.

WIDTH

NARROW EDGE BINDING	LENGTH	WIDTH								
		24"	30"	36"	42"	48"	60"	72"	84"	96"
Beige	36"	\$28	\$29	\$31	\$32	\$34	\$37	\$40	\$43	\$46
Black	48"	\$34	\$35	\$37	\$38	\$40	\$43	\$46	\$49	\$52
Chocolate	54"	\$37	\$38	\$40	\$41	\$43	\$46	\$49	\$52	\$55
Copper	60"	\$40	\$41	\$43	\$44	\$46	\$49	\$52	\$55	\$58
Cream	66"	\$43	\$44	\$46	\$47	\$49	\$52	\$55	\$58	\$61
Desert Sand	72"	\$46	\$47	\$49	\$50	\$52	\$55	\$58	\$61	\$64
Light Beige	78"	\$49	\$50	\$52	\$53	\$55	\$58	\$61	\$64	\$67
Natural	84"	\$52	\$53	\$55	\$57	\$58	\$61	\$64	\$67	\$70
Sienna	96"	\$58	\$60	\$61	\$63	\$64	\$67	\$70	\$73	\$76
White	108"	\$64	\$66	\$67	\$69	\$70	\$73	\$76	\$79	\$83

WIDE EDGE BINDING	LENGTH	WIDTH								
		24"	30"	36"	42"	48"	60"	72"	84"	96"
Beige	36"	\$36	\$38	\$40	\$42	\$44	\$48	\$52	\$56	\$60
Black	48"	\$44	\$46	\$48	\$50	\$52	\$56	\$60	\$64	\$68
Chocolate	54"	\$48	\$50	\$52	\$54	\$56	\$60	\$64	\$68	\$72
Copper	60"	\$52	\$54	\$56	\$58	\$60	\$64	\$68	\$72	\$76
Cream	66"	\$56	\$58	\$60	\$62	\$64	\$68	\$72	\$76	\$80
Desert Sand	72"	\$60	\$62	\$64	\$66	\$68	\$72	\$76	\$80	\$84
Light Beige	78"	\$64	\$66	\$68	\$70	\$72	\$76	\$80	\$84	\$88
Natural	84"	\$68	\$70	\$72	\$74	\$76	\$80	\$84	\$88	\$92
Sienna	96"	\$76	\$78	\$80	\$82	\$84	\$88	\$92	\$96	\$100
White	108"	\$84	\$86	\$88	\$90	\$92	\$96	\$100	\$104	\$108

FOLDING DOOR PRICING – ONE WAY OPENING

5% FULLNESS

WIDTH

PRICE GROUP A	LENGTH	48"	60"	72"	84"	96"	120"	Per extra 12" up to 192"
		Aspen White						
Boardwalk	48"	\$296	\$349	\$400	\$462	\$524	\$641	\$59
Borneo Dappled	60"	\$331	\$391	\$449	\$519	\$588	\$721	\$67
Devon Coffee								
Devon Ivory	72"	\$365	\$433	\$498	\$576	\$652	\$802	\$74
Devon Maple								
Devon White	84"	\$399	\$474	\$548	\$633	\$717	\$882	\$83
Durban								
Panama Sand	96"	\$433	\$516	\$597	\$689	\$781	\$963	\$92
Penang Oak								
Split Bamboo								
Sunshade Brown								
Valance		\$89	\$91	\$117	\$119	\$148	\$184	\$13

PRICE GROUP B	LENGTH	48"	60"	72"	84"	96"	120"	Per extra 12" up to 192"
		Bamboo Forest						
Barcelona	48"	\$315	\$373	\$428	\$495	\$561	\$688	\$63
Bora Bora	60"	\$354	\$421	\$484	\$560	\$635	\$780	\$73
Java Cocoa								
Osaka	72"	\$393	\$468	\$541	\$625	\$709	\$873	\$82
Plaza Khaki								
Plaza Tan	84"	\$432	\$516	\$597	\$690	\$783	\$965	\$91
Rangoon								
Sahara	96"	\$471	\$563	\$654	\$756	\$857	\$1,057	\$101
Shoji								
Tamarind Sunset								
Valance		\$98	\$102	\$130	\$134	\$166	\$207	\$15

PRICE GROUP C	LENGTH	48"	60"	72"	84"	96"	120"	Per extra 12" up to 192"
		Aspen Cedar						
Aspen Ebony	48"	\$348	\$413	\$477	\$552	\$626	\$769	\$69
Aspen Walnut	60"	\$395	\$471	\$545	\$631	\$716	\$882	\$82
Baja Walnut								
Cape Town	72"	\$442	\$529	\$614	\$710	\$806	\$994	\$94
Mandalay Umber								
Plaza Mahogany	84"	\$489	\$587	\$682	\$790	\$896	\$1,106	\$104
Sedona								
Sunshade White	96"	\$536	\$644	\$751	\$869	\$989	\$1,219	\$117
Valance		\$114	\$121	\$151	\$157	\$195	\$231	\$18

PRICE GROUP D	LENGTH	48"	60"	72"	84"	96"	120"	Per extra 12" up to 192"
		Nassau Mahogany						
Woodweave Brown	48"	\$373	\$445	\$514	\$596	\$676	\$832	\$78
Woodweave Espresso	60"	\$426	\$510	\$592	\$686	\$779	\$960	\$91
	72"	\$479	\$576	\$670	\$776	\$881	\$1,088	\$103
	84"	\$533	\$642	\$748	\$866	\$984	\$1,216	\$116
	96"	\$586	\$707	\$826	\$957	\$1,086	\$1,344	\$128
Valance		\$127	\$136	\$167	\$176	\$219	\$274	\$20

20% FULLNESS: **20%**

SPLIT DRAW: **\$122**

PRIVACY LINER: **30%**

BLACK-OUT LINER: **40%**

NET FREIGHT SURCHARGE: **\$20**

All tracks and valance boards over 100" wide will be spliced to avoid oversize freight charges

SLIDING PANEL PRICING

WIDTH

PRICE GROUP A									
LENGTH		60"	72"	84"	96"	108"	120"	132"	144"
	Aspen White								
	Boardwalk								
	Borneo Dappled								
	Devon Coffee								
Devon Ivory									
Devon Maple									
Devon White									
Durban									
Panama Sand									
Penang Oak									
Split Bamboo									
Sunshade Brown									
Valance		\$34	\$41	\$48	\$55	\$62	\$69	\$76	\$83

PRICE GROUP B									
LENGTH		60"	72"	84"	96"	108"	120"	132"	144"
	Bamboo Forest								
	Barcelona								
	Bora Bora								
	Java Cocoa								
Osaka									
Plaza Khaki									
Plaza Tan									
Rangoon									
Sahara									
Shoji									
Tamarind Sunset									
Valance		\$36	\$43	\$51	\$58	\$65	\$72	\$79	\$87

PRICE GROUP C									
LENGTH		60"	72"	84"	96"	108"	120"	132"	144"
	Aspen Cedar								
	Aspen Ebony								
	Aspen Walnut								
	Baja Walnut								
Cape Town									
Capri Natural									
Jakarta Spice									
Mandalay Umber									
Plaza Mahogany									
Prairie Sunset									
Sakura Oregon									
Savanna Husk									
Valance		\$38	\$45	\$53	\$60	\$68	\$75	\$83	\$90

PRICE GROUP D									
LENGTH		60"	72"	84"	96"	108"	120"	132"	144"
	Catalina								
	Nassau Mahogany								
	Natural Jute								
	Prairie Golden								
Prairie Snow									
Prairie White									
Tradewind Natural									
Woodweave Brown									
Woodweave Espresso									
Valance		\$42	\$51	\$59	\$68	\$76	\$85	\$93	\$102

PRIVACY LINER: 30%

WIDE EDGE BINDING: \$150

BLACK-OUT LINER: 40%

NET FREIGHT SURCHARGE: \$20

All tracks and valance boards over 100" wide will be spliced to avoid oversize freight charges

PRO DESIGN WOVEN WOODS WARRANTY

WHAT IS COVERED BY THIS WARRANTY?

This woven wood shade is warranted against defects in materials and workmanship, provided that:

1. The product was installed according to the product instructions.
2. Pro Design recommendations were followed regarding limitations and specifications of the product.

Pro Design reserves the right to determine if your shade warrants a repair or partial replacement of any parts. If necessary, Pro Design will replace your shade with a new shade of equal or superior value. This shall be your sole remedy under this warranty.

All motors, remote controls and wand motors are warranted for a period of five years from the date of purchase.

WHO IS COVERED BY THIS WARRANTY?

This warranty applies only to the original retail purchaser with proof of purchase in the USA.

WHAT IS NOT COVERED BY THIS WARRANTY?

Your Pro Design woven wood shade is made from natural materials, which will show natural variations in color, texture and weave. They may also show some fading and discoloration over time, or cracking, twisting, bowing or stretching and shrinkage due to exposure to direct sunlight or excessive moisture. These are not considered defects for the purposes of this warranty.

This warranty does not cover the removal or installation of original or replacement shades. This warranty does not cover damage or defects caused by, or resulting from improper maintenance, neglect or improper use, wear and tear, abuse, neglect, accidents, alteration, commercial use, installation, removal or reinstallation or exposure to excessive moisture.

Failure to follow the proper installation, charging and use instructions will invalidate the warranty for motors, remotes and wand motors.

YOUR RIGHTS UNDER STATE LAW

This warranty gives you specific legal rights. You may also have other rights which may vary from State to State. In no event shall Pro Design be liable for incidental or consequential damages or for any other direct or indirect damage, loss, cost, expense or fee. Some states do not allow the exclusion or limitation of incidental or consequential damages, so the above limitation or exclusion may not apply to you. This warranty is exclusive and in lieu of all other obligations, liabilities or warranties.

WALDEN
PREMIER