

2019 Product Guide



WALDEN
SELECT

NATURAL WOVEN MATERIALS REFERENCE

PATTERN CODE	PATTERN NAME	PRICE GROUP	FOLDING DOOR	SLIDING PANEL	COORDINATED EDGE BINDING COLOR	COORDINATED WAND COLOR
WS-1922	Antilles Mist	D	N	Y	Beige	Beige
WS-1903	Antilles Sand	D	N	Y	Desert Sand	Beige
WS-1905	Antilles Seagrass	D	N	Y	Desert Sand	Beige
WS-5322	Cala Platinum	B	Y	Y	Gray	Gray
WS-5302	Cala Titanium	B	Y	Y	Gray*	Gray
WS-1322	Como Charcoal	E	N	Y	Beige*	Beige
WS-1302	Como Ecrú	E	N	Y	Cream*	Beige
WS-1323	Como Gray	E	N	Y	Beige*	Beige
WS-1388	Como Midnight	E	N	Y	Black*	Black
WS-1303	Como Umber	E	N	Y	Beige*	Beige
WS-0721	Malvern Light Gray	B	Y	Y	Gray	Gray
WS-0723	Malvern Platinum	B	Y	Y	Gray	Gray
WS-0702	Malvern Chalk	B	Y	Y	White	White
WS-0722	Malvern Gray	B	Y	Y	Gray	Gray
WS-0802	Metro Chalk	C	Y	Y	White	White
WS-0822	Metro Smoke	C	Y	Y	Beige	Beige
WS-1806	Montana Inkwash	D	N	Y	Black	Black
WS-1888	Montana Mineral	D	N	Y	Black	Black
WS-1605	Nantucket Sea Mist	D	N	Y	Desert Sand	Beige
WS-0522	Osaka Granite	B	Y	Y	Gray	Gray
WS-0502	Osaka Snow	B	Y	Y	White	White
WS-1516	Parchment Husk	D	N	Y	Desert Sand**	Beige
WS-1517	Portland Inkwash	D	N	Y	Brown**	Bronze
WS-1522	Portland Sky	D	N	Y	Cream**	Beige
WS-0602	Pudong White	A	Y	Y	White	White
WS-1101	Selene Natural	E	N	Y	Natural*	Beige
WS-1102	Selene White	E	N	Y	Cream*	White
WS-0004	Soft Jute Beige	F	N	Y	Natural*	Beige
WS-0022	Soft Jute Gray	F	N	Y	Beige*	Beige
WS-0001	Soft Jute White	F	N	Y	Cream*	Beige
WS-1504	Sonoma Dusk	D	N	Y	Desert Sand**	Bronze
WS-9077	Terra Oak	C	N	Y	Desert Sand	Beige
WS-0833	Tortola Natural	D	N	Y	Desert Sand	Bronze
WS-0288	Umbria Ink	C	Y	Y	Black	Black
WS-0222	Umbria Mist	C	Y	Y	Beige	Beige
WS-0219	Umbria Sepia	C	Y	Y	Beige	Bronze

EDGE BINDINGS

COLOR NUMBER	COLOR	WIDTH
NARROW EDGE BINDING		
N003	Beige	1"
N015	Black	1"
N010	Chocolate	1"
N001	Cream	1"
N005	Desert Sand	1"
N022	Gray	1"
N007	Mocha	1"
N018	Natural	1"
N009	Pecan	1"
N016	White	1"

COLOR NUMBER	COLOR	WIDTH
WIDE EDGE BINDING		
W003	Beige	3"
W015	Black	3"
W010	Chocolate	3"
W001	Cream	3"
W005	Desert Sand	3"
W022	Gray	3"
W007	Mocha	3"
W018	Natural	3"
W009	Pecan	3"
W016	White	3"

LINERS

COLOR NUMBER	COLOR
PRIVACY LINERS	
LF82	Privacy Beige
LF10	Privacy Black
LF58	Privacy Gray
LF62	Privacy Soft White
BLACK-OUT LINERS	
BO03	Black-Out Beige
BO01	Black-Out White

Privacy Liners are the same color on both sides.

Black-Out Liners are off-white to the street.

All fabrics have a maximum width of 96".

*Edge Binding is required for all Como, Selene, and Soft Jute patterns.

**Edge Binding is recommended for all Parchment, Portland, and Sonoma patterns.

SHADE STYLES

All standard shade styles operate with a cord lock and are supplied with cord cleats to keep the cords tidy and away from children or pets.

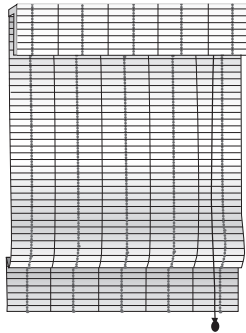
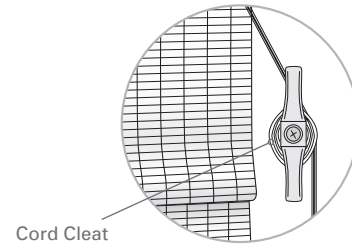
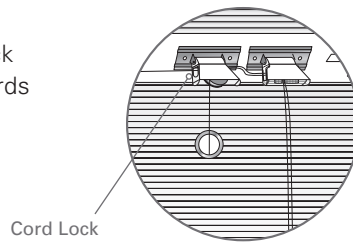

STANDARD ROMAN SHADE

Shade is raised by means of cords, which hang in front of the shade. Includes a 6" valance to conceal the components. When raised, the material rises from the bottom in flat folds.

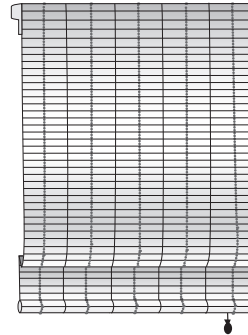

WATERFALL SHADE

Shade is raised by means of cords, which hang behind the shade. Material is attached to the front of the head rail, without a valance. When raised, the material rises from the bottom in flat folds.

Optional back valance is available upon request.

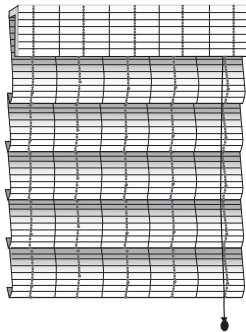

HOBBLED SHADE

Shade is constructed the same way as a standard roman shade, with a 6" valance and cords in front of the shade. When lowered, the shade maintains its folds, giving it a soft fabric look.

NOTE: *Hobbled shades contain more material and so are heavier than standard roman shades.*

VALANCE RETURNS

Valance returns are supplied with all outside mount shades. They are also available upon request with inside mount shades.

Standard valance returns are the same length as the valance: 6" long. They are made of the chosen bamboo pattern, and attached with velcro.

Short valance returns (2" long) are available upon request. Short returns conceal the end of the head rail and components; they remain clear of the shade when it is fully raised.

FABRIC VALANCE RETURNS

For shades with edge binding, returns made from the edge binding fabric are available as a surcharge option.

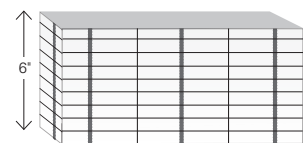

6" Standard Valance Return

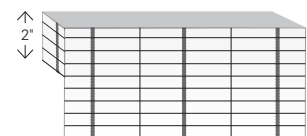

2" Short Valance Return

SHADE OPTIONS

LINERS

A liner can be ordered attached to the back of the shade or as a separately operable, movable liner (see Twin Shade below).

ATTACHED LINERS

Attached liners are available in privacy or black-out. They are secured to the back of the shade by stitches at each side of the liner. If a shade is lined, the valance will automatically be lined with the same material.

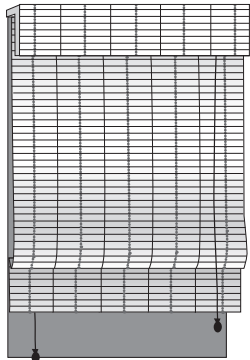

shown with controls on opposite sides

TWIN SHADE

Features two separate, independently operated shades on one head rail. The front shade can be either a standard or waterfall natural woven shade.

A separate liner shade is attached to the back of the head rail and both shades operate independently. Lift cords can be on the same side (factory standard) or opposite sides of the shade.

Available with Roll Ease® clutch control for the front, natural woven shade, or for both shades.

See Specifications for head rail sizes.

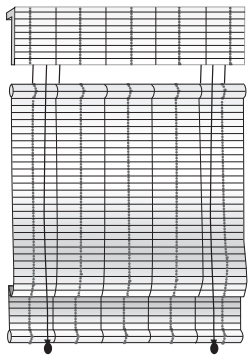

controls always on opposite sides

TOP-DOWN BOTTOM-UP SHADES

Top-Down Bottom-Up (TDBU) shades can be raised from the bottom or lowered from the top. This is accomplished with two separate sets of control cords positioned at opposite sides of the shade. Available with liners and edge binding.

To conceal the cord locks and pulleys each shade will be finished with a 6" lined valance. This is included in the TDBU surcharge.

The maximum width for TDBU shades is 84". TDBU shades are not available in waterfall style, or as multiple shades on one head rail.

MULTIPLE SHADES ON ONE HEAD RAIL

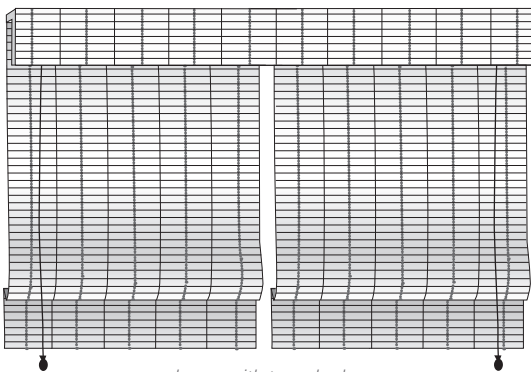

shown with two shades

Shades are available with 2-on-1 or 3-on-1 head rail. The maximum total width is 115" and the gap between shades will be no more than 1/2". The maximum width for a common valance is 96"; wider valances will be made in sections to match the individual shade widths.

Cord locks, clutches, cordless controls and motorization (wand or remote) can be used for these shades. Pay careful attention to make sure there are suitable locations for cord tensioners or cord cleats when specifying multiple shades on one head rail, particularly for the middle shade in 3-on-1 head rail units.

It is possible to operate two shades with just one clutch. A 2-on-1 shade can be specified with only one control on one side of the head rail. A 3-on-1 shade can be specified with only two controls, one on each side of the head rail.

SHADE CONTROL OPTIONS

CLUTCH CONTROL AND CONTINUOUS CORD LOOP (CCL)

Clutch controls are available with all shade styles except TDBU. All clutch control shades come with cord tensioners, which should be securely fixed to the wall to allow for the shade to operate freely and to keep dangerous hanging loops away from children and pets.

Cord loops are available in one foot increments from 2' to 8'. The factory will choose the length closest to $\frac{2}{3}$ rds shade height, unless otherwise requested. Metal chain loops are available and can be made to custom lengths as a surcharge option.

The stack thickness on longer shades can interfere with both cord loop operation and cord tensioner installation, particularly for outside mount applications. We recommend ordering clutch control shades "cord adjacent;" this means the head rail and valance will be made $\frac{5}{8}$ " wider than the shade on the control side allowing the chain to hang to the side of the shade. Please specify when ordering if you would like the shade to be completed as "cord adjacent."

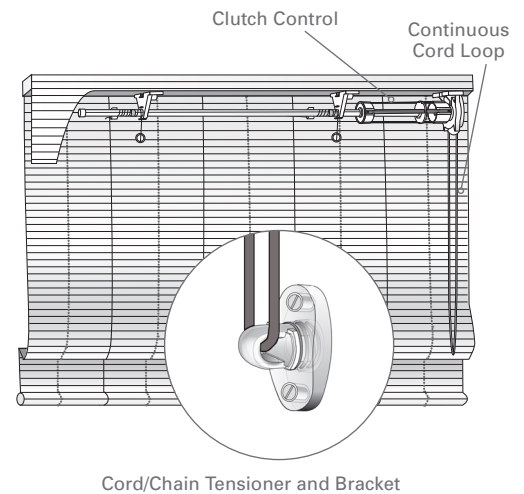

Cord/Chain Tensioner and Bracket

CORDLESS SHADES

Cordless shades operate with no lift cords on the front of the shade. The shade is lowered by pulling on the hem bar. A spring control system, located under the wooden head rail, holds the shade in place at any desired position. Clear grips are added to the hem bar of cordless shades.

The cordless option is not available on TDBU shades; hold down brackets cannot be used with cordless shades.

Cordless shades are available up to 96" wide and 96" long and will be mounted on standard depth head rails (see Specifications for details).

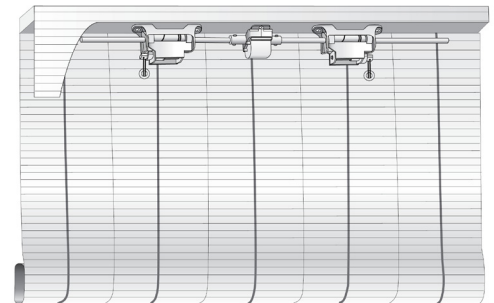

Cordless Shade

MOTORIZED SHADE OPTIONS

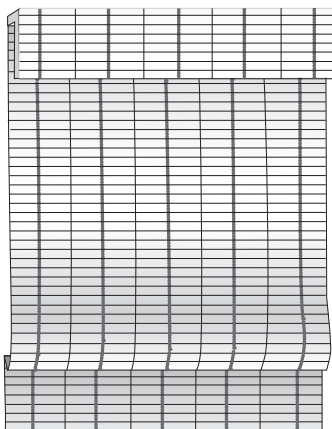

Remote Control Shade

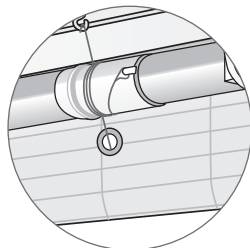

Motor Tube and Spindle

REMOTE CONTROL SHADES

Remote control motorized shades are powered by an internal lithium-ion battery. Operation of the shade is controlled by either a single- or multi-channel radio frequency remote.

The single-channel remote can operate up to 20 shades in one group, with a range of about 100 feet. The multi-channel remote has 15 channels and is recommended to operate shades of different lengths. Wall switches are an available alternative to the remotes.

The Connector Motor Hub brings automated capabilities to remote control motorized shades. Hubs operate through your wi-fi network and allow shade operation through smart phones and select smart home technologies.

The motor battery is recharged using an AC power adaptor, which plugs into a port in the head of the motor.

A solar panel charger alternative is also available; once properly installed it is a permanent power source. Some restrictions apply.

AC motors can be specified for larger shades. Please call for specifications/quotes.



Remote Control (single-channel)

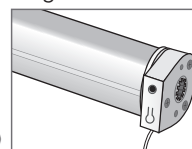

Charging Port in Motor Head



Connector Motor Hub

SHADE CONTROL OPTIONS

WAND CONTROL SHADES

Wand control motorized shades are powered by the same internal lithium-ion battery as remote control shades. The motor is controlled using a wand which hangs down to the side of the shade.

Waterfall shades cannot be outfit with wand controls.

Wands are available in 4 lengths: 24", 36", 48" and 60".
Available colors include: white, beige, gray, bronze and black.
See image on page 17.

Wand control shade motor batteries are recharged via a mini USB power adaptor which plugs into the end of the wand.

All wand control shades will be made with the head rail and valance $\frac{5}{8}$ " wider than the shade fabric on the control side allowing the wand to hang to the side of the shade. This may cause a light gap on black-out shades.

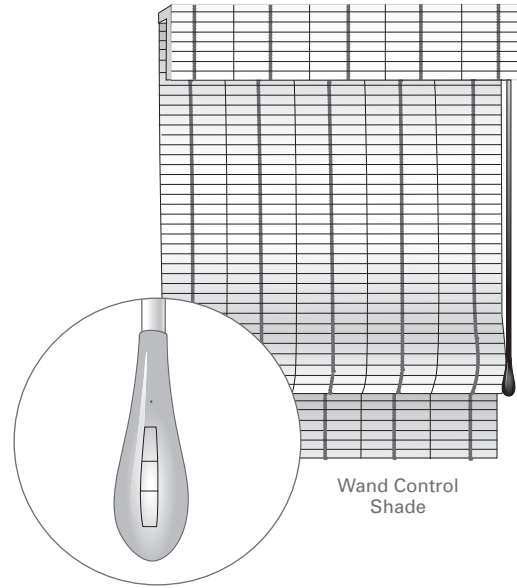

Wand Control Shade

OUTSIDE MOUNT

The shade fabric will be made at the ordered width.

The head rail and valance will be **$\frac{5}{8}$ " wider** on the control side.

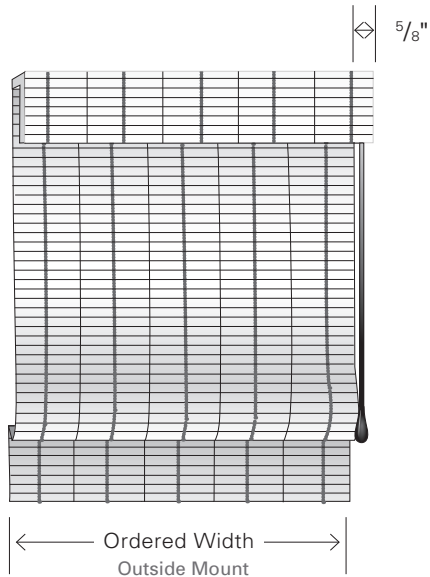

INSIDE MOUNT

The shade, head rail and valance will be made with a $\frac{3}{8}$ " IB deduction.

The shade fabric will be cut an extra **$\frac{5}{8}$ " narrower** on control side.

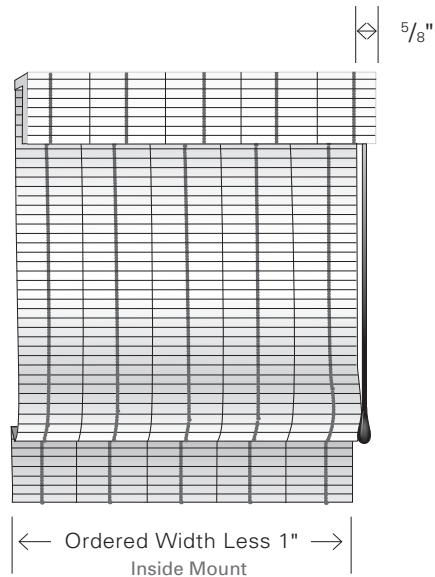

SHADE ADDITIONAL OPTIONS

ADDITIONAL OPTIONS

LINED VALANCE

Lined valances are recommended to conceal the head rail components where an open-weave pattern is selected. All TDBU shades are made with lined valances as standard.

EDGE BINDINGS

Available in two widths: 1" ($\frac{1}{2}$ " on the face of the shade) and 3" ($1\frac{1}{2}$ " on the face of the shade).

Edge binding is applied to the sides of both the shade and valance. It is not applied to the bottom of either.

Hold down brackets can be requested for edge bound shades unless they are finished with cordless control.

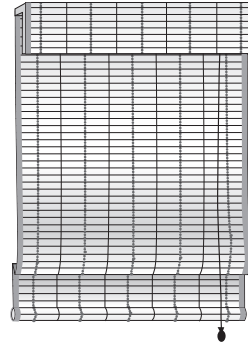

Standard Shade
shown with narrow edge binding

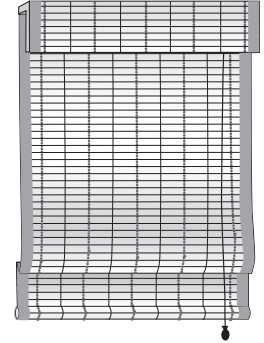

Standard Shade
shown with wide edge binding

CUT OUTS

Cut outs can be taken from either side of the shade. Please provide exact dimensions and the locations of cut outs required.

Cut outs are not available with edge binding.

There may be limitations to what can be cut out, based upon the size and specifications of the shade. The factory will review all orders for cut outs and provide confirmation of each order within 24 hours.

BRACKETS AND SPACER BLOCKS

Hold down brackets are supplied upon request for all but cordless shades.

Spacer blocks measuring $\frac{3}{8}$ " are available upon request. Maximum of 2 spacer blocks per bracket recommended.

SHADE SPECIFICATIONS

	MINIMUM WIDTH	MAXIMUM WIDTH	MINIMUM HEIGHT	MAXIMUM HEIGHT	IB DEDUCTION (WIDTH)	FLUSH IB DEPTH (top mount w/brkt)	MINIMUM IB DEPTH (top mount w/brkt)
STANDARD (CORDED)	12"	96"	18"	108"	3/8"	2 1/2"*	3/4"
NARROW HEAD RAIL (CORDED)	12"	96"	18"	108"	3/8"	2"*	3/4"
CLUTCH and CCL	18"	96"	18"	108"	3/8"	3 3/4"*	3/4"
CORDLESS	18"	96"	18"	96"	3/8"	2 1/2"*	3/4"
STANDARD TWIN SHADE	12"	96"	18"	108"	3/8"	3 3/4"*	3/4"
TOP-DOWN BOTTOM-UP (TDBU)	12"	84"	18"	108"	3/8"	2 1/2"*	3/4"
REMOTE CONTROL	23"	96"	18"	108"	3/8"	3 3/4"*	3/4"
WAND CONTROL	23"	96"	18"	108"	3/8"	3 3/4"*	3/4"
MULTIPLE SHADES ON ONE HR	-	115"	-	-	-	-	-
COMMON VALANCE	-	96"	-	-	-	-	-

* Flush IB depth is head rail depth plus 1" when using standard bracket. Exact measurement will vary slightly based upon fabric thickness.

BRACKET DIMENSIONS

Height: 1 1/2"
Depth: 1 3/4"

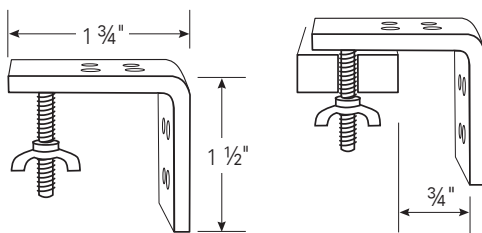

RING SPACING

Rings spaced 7" apart on shade back.

STACK HEIGHT

Approximately (all lengths): 8" to 10"

HEAD RAIL DIMENSIONS

Middle support brackets will be supplied for all shades over 41" wide.

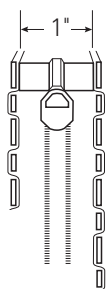

NARROW HEAD RAIL
(Custom Order Only)
• Standard Shades
• Waterfall Shades
• TDBU Shades

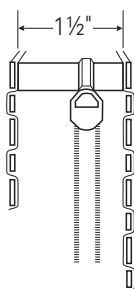

STANDARD HEAD RAIL
• Standard Shades
• Waterfall Shades
• TDBU Shades

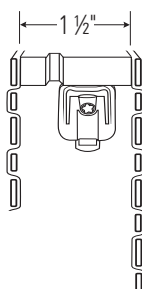

CORDLESS HEAD RAIL
• Standard Shades
• Waterfall Shades

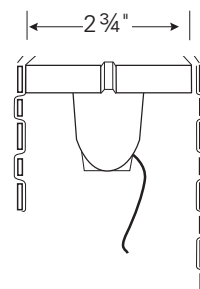

MOTORIZED HEAD RAIL
REMOTE OR WAND CONTROL
• Standard Shades
• Waterfall Shades

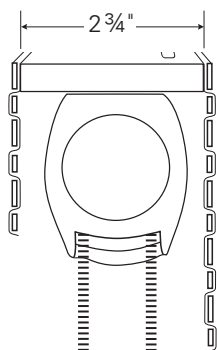

CLUTCH SHADE
with Continuous Cord Loop
(shown)

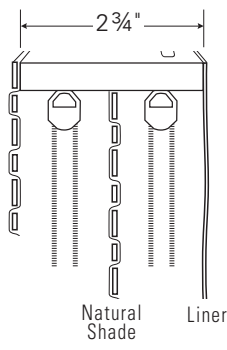

STANDARD TWIN SHADE
Controls Same Side (shown)
or Opposite Sides

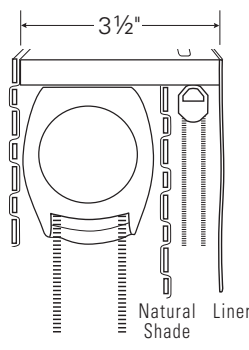

TWIN SHADE w/CLUTCH
(Clutch Control for Front Shade Only)
Controls Same Side (shown)
or Opposite Sides

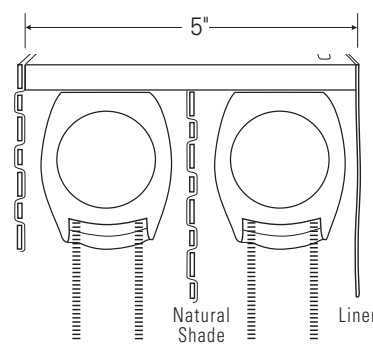

TWIN SHADE w/2 CLUTCHES
Controls Same Side (shown)
or Opposite Sides

FOLDING DOORS

Folding doors are ideal for large windows or doors and hang vertically from hangers, which slide smoothly inside an aluminum track. On each side of the door are wood bars with handles, if desired. The wood bars come in three colors, and are selected to coordinate with the chosen pattern. All folding doors are provided with a brown track; white is available upon request.

Check the Materials Reference table for patterns which are available to be made as folding doors.

Folding doors come in one of two configurations: one-way opening or center opening.

ONE-WAY OPENING

When open, the material stacks back either to the right or the left. Specify on the order form which side of the door the drapery will stack to.

NOTE: *If you want the material to stack back completely clear of the window, for an unobstructed view when the door is open, allow for the width of the stack in the overall width of the door. See "Specifications" for more details.*

CENTER OPENING (Split Draw)

The door is made from two panels, which are equal width and meet in the middle. They open to opposite sides of the window.

Each panel has a wood bar on each side and the two middle bars have small, countersunk magnets which hold the two bars together tightly when the panels are in the closed position.

DRAPERLY STYLE

Folding doors can be ordered "drapery style," which means no edge bars, but wide edge binding on all four sides of the panel for a softer look.

Drapery style folding doors can also be ordered as one-way or center opening.

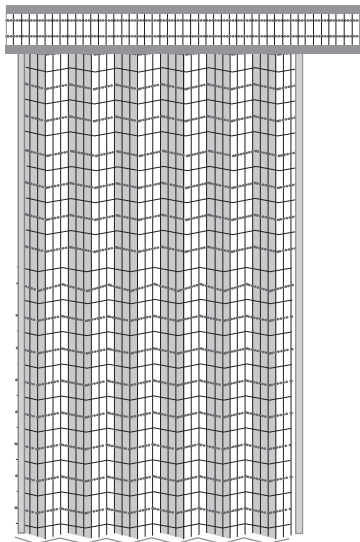

One-Way Left Stack
shown with valance

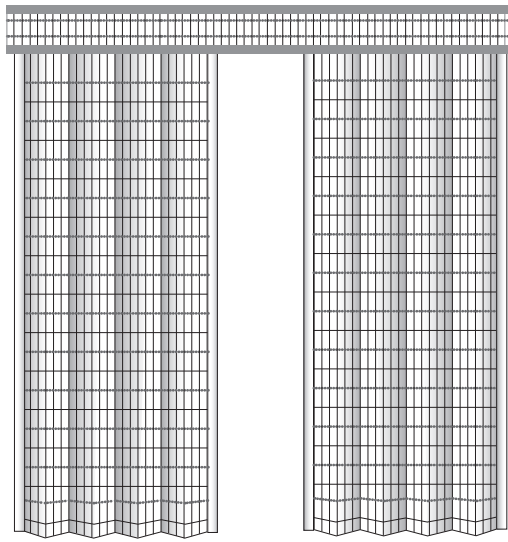

Center Opening – Split Draw
shown with valance

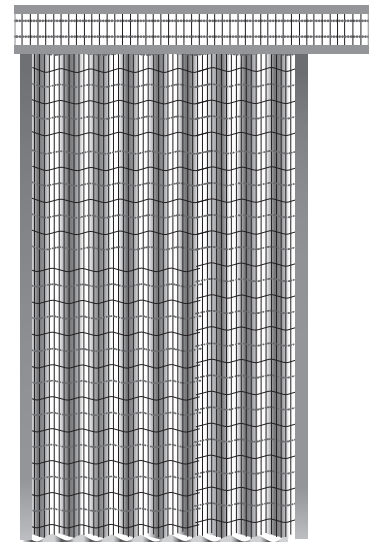

Drapery Style Left Stack
shown with valance

FOLDING DOOR OPTIONS

FULLNESS

The standard folding door comes with 5% fullness, which means that it lies nearly flat when fully extended. Folding doors can be ordered with 20% fullness, which gives fuller folds; this is a surcharge option.

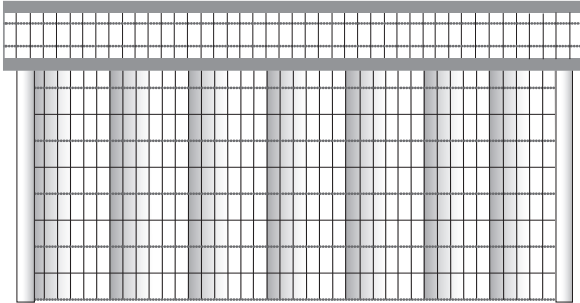

5% Fullness (fully extended)
shown with valance

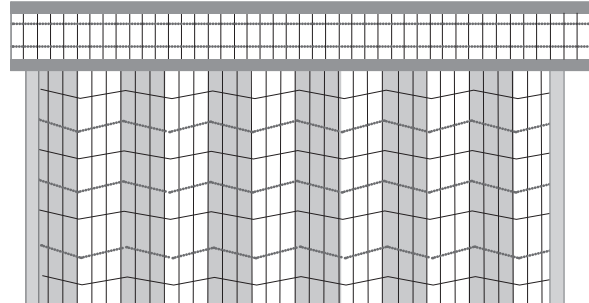

20% Fullness (fully extended)
shown with valance

LINERS

Liners are available in privacy or black-out. They are attached to the top of the folding door and are secured down both sides beneath the wood bars.

VALANCE

Standard folding doors come with track and panels. Adding a valance provides a decorative touch. It also conceals the track and hangers, and blocks any light gap between the track and the top of the door fabric.

The valance is 8" long and is mounted to a wooden board, 5 1/2" deep and 3/4" thick. The valance is attached to the front edge of the board by velcro.

The valance is oriented in the same direction as the door (vertically) and is edge-bound on the top and bottom.

For inside mount shades, the valance will cover the front of the valance board only. For outside mount shades, the valance will be made to wrap around both ends of the valance board.

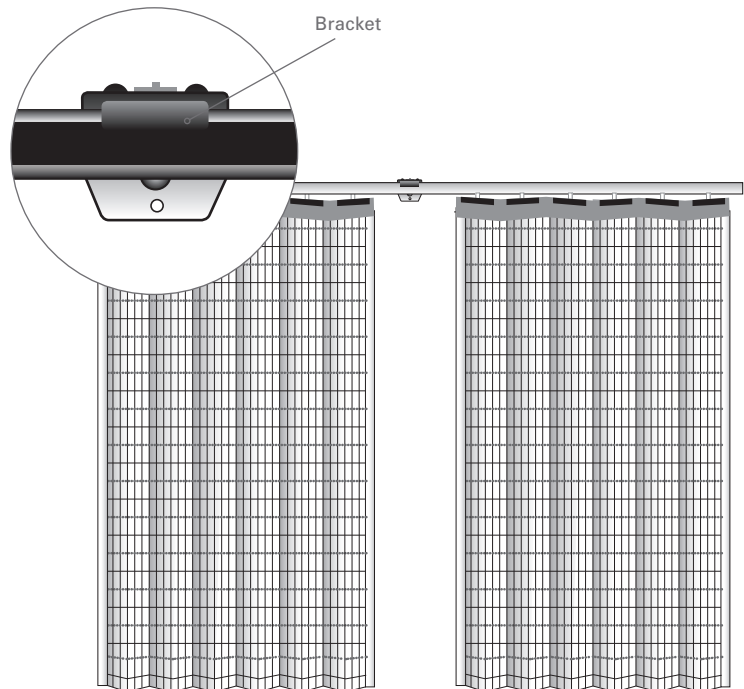

Center Opening – Split Draw
shown without valance

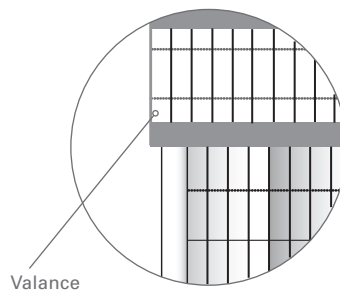

Valance

FOLDING DOOR SPECIFICATIONS

SIZE LIMITATIONS

Minimum Width: 24"
Maximum Width: 192"

Minimum Height: 24"
Maximum Height: 96"

Tracks and valance boards wider than 100" are spliced to avoid oversize freight charges.

IMPORTANT INFORMATION FOR ORDERING AND INSTALLING FOLDING DOORS

DOORS WITHOUT A VALANCE

For doors without a valance, the height of the folding door is measured from the top of the track to the bottom of the fabric.

There is a gap of approximately $\frac{3}{4}$ " between the top of the track and the material. The factory will deduct this amount from the ordered length when they make the fabric panel.

DOORS WITH A VALANCE

For doors with a valance, the height of the folding door is measured from the top of the valance board to the bottom of the fabric.

The valance board is $\frac{3}{4}$ " thick and there is $\frac{3}{4}$ " between the top of the track and the top of the material. The factory will deduct $1\frac{1}{2}$ " from the ordered length when they make the fabric panel.

INSIDE MOUNT MEASUREMENTS

Minimum Inside Mount Depth: 2"

Check for any obstructions, such as trim or handles that may interfere with the opening and closing of the door.

Inside Mount Deductions:

Width: $\frac{1}{4}$ "
Height: $\frac{3}{4}$ "

No deductions are made to the width or height of outside mount doors.

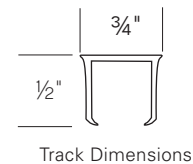
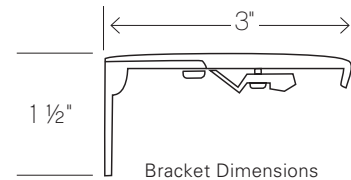
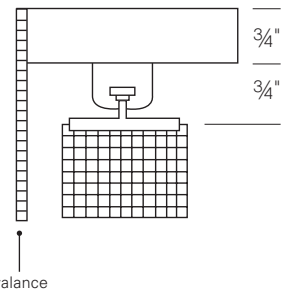
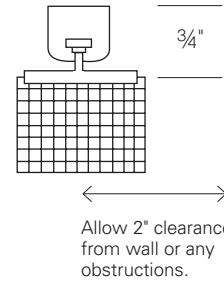

STACKING CHART (5% FULLNESS)

WIDTH	STACK
36"	8 $\frac{1}{2}$ "
42"	9"
48"	9 $\frac{1}{2}$ "
60"	11"
72"	12"
84"	13"
96"	14"

Center opening (or split draw) folding doors will open into two equal stacks on each side. For example a 96" center opening will have two stacks each the size of a 48" one-way opening door: 9 $\frac{1}{2}$ ".

20% fullness folding doors will stack approximately 1" wider for small doors and 1 $\frac{1}{2}$ " wider for larger doors than same size at 5% fullness.

All stacking dimensions are approximate and will vary by pattern.

SLIDING PANELS

Sliding panels provide a clean, contemporary look for large windows and doors. Overlapping panels are suspended from hangers, which glide smoothly on an aluminum track and pass in front of each other, allowing the panels to stack back away from the window. Check the Materials Reference table for patterns which are available to be made as Sliding Panels.

The panels are supplied with narrow edge binding to protect them from wear and tear and are custom-sized, based on the ordered width and the number of panels. Sliding panels are operated with wood wands; a center opening sliding panel will have two wands.

NOTE: Bamboo and natural materials can stretch or shrink, so we recommend that panels are ordered with at least $\frac{3}{4}$ " clearance from the ground. Also, when shipped from the factory, panels may be slightly different lengths (up to $\frac{1}{2}$ " from the ordered length). Shorter panels can be made longer by gently pulling on the bottom of the panel until they are the same length as longer panels.

NO CHARGE OPTIONS

ONE-WAY OPENING

When open, all of the panels stack back to either the right or the left. Specify on the order form which side of the window the panels will stack to.

NOTE: If you want the panels to stack completely away from the window for an unobstructed view, allow for the panel width in the overall width of the shade. See "Specifications" for more details.

The standard configuration is for the front panel to be stationary and all other panels stack behind it. Reverse stacking is available upon request, with the rear panel stationary. Free-floating panels are also available.

CENTER OPENING

Center-opening (or split draw) sliding panels must be made with an even number of panels and the panels will stack back to both sides.

The standard configuration is for the front panel on each side to be stationary, and the other panels stack behind it. Reverse stacking is available upon request, with the rear panel stationary. Free-floating panels are also available.

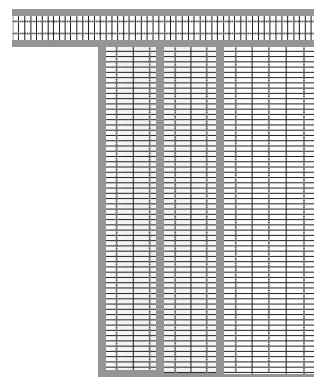

One-Way Right Stacked

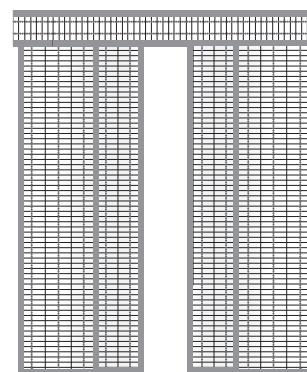

Center Opening

SLIDING PANEL SURCHARGE OPTIONS

LINERS

Available in privacy or black-out, and sewn under the edge binding on all four panel sides.

VALANCE

Valances are 8" long and attached to the front and sides of the track by velcro. If a valance is part of the original sliding panel order, the velcro for the valance will be riveted to the front of the track to ensure a lasting bond.

Valances are cut up the roll, so they wrap around the ends of the track. This means the valance material is rail-roaded and will be oriented differently to the panels. For inside mount sliding panels, the valance will cover the front of the track only. For outside mount sliding panels the valance will be made to wrap around both ends of the track.

When ordered separately, both velcro halves are provided, but the bond between the velcro and the track will not be as durable.

WIDE EDGE BINDING

Panels will come with narrow (1") edge binding as standard, which means that $\frac{1}{2}$ " is visible on the face of the panels. Wide (3") edge binding is also available in the same colors as a surcharge option.

SLIDING PANEL SPECIFICATIONS

SIZE LIMITATIONS

Minimum Width: 48" Minimum Height: 24"
 Maximum Width: 144" Maximum Height: 108"

Tracks wider than 100" are spliced to avoid oversize freight charges.

STANDARD PANEL CONFIGURATIONS

WIDTH	TYPE OF OPENING	# OF PANELS	TRACK TYPE
48" – 84"	One-Way	3 Panels	3 Channel
	Center Opening	4 Panels	4 Channel
84 ¼" – 120"	One-Way	4 Panels	4 Channel
	Center Opening	4 Panels	4 Channel
120 ¼" – 144"	One-Way	5 Panels	5 Channel
	Center Opening	6 Panels	3 Channel

TYPICAL PANEL SIZES (OUTSIDE MOUNT SHADE)

WIDTH	ONE-WAY DRAW		CENTER OPENING	
60"	3 panels	22 ¼"	4 panels	17 ¾"
72"	3 panels	26 ¼"	4 panels	20 ¾"
84"	3 panels	30 ¼"	4 panels	23 ¾"
96"	4 panels	26 ¾"	4 panels	26 ¾"
108"	4 panels	29 ¾"	4 panels	29 ¾"
120"	4 panels	32 ¾"	4 panels	32 ¾"
132"	5 panels	28 ¾"	6 panels	24 ¾"
144"	5 panels	31 ¾"	6 panels	26 ¾"

PANEL SIZE CALCULATIONS

To calculate the approximate panel width, use the ordered width and the number of panels.

Deduct one from the number of panels and multiply this number by 2.5. Then add this number to the ordered width and divide the resulting number by the number of panels.

For example: For a sliding panel order with an 80" width and 5 panels, each panel will be approximately 18" wide.

$$5 \text{ (panels)} - 1 = 4$$

$$4 \times 2.5" = 10"$$

$$80" \text{ (ordered width)} + 10" = 90"$$

$$90" / 5 \text{ (panels)} = 18" \text{ panel width}$$

TRACK DIMENSIONS

TRACK DEPTHS	
3 Channel	2"
4 Channel	2 ¾"
5 Channel	3 ¾"

The distance from the top of the track to the top of the panels is 1". The factory will take account of this distance when calculating the panel length.

MOUNTING DEPTHS

	3 TRACK	4 TRACK	5 TRACK
Minimum IB	2"	2 ¾"	3 ¾"
Flush IB	2 ½"	3 ¼"	3 7/8"

Wall or Face Mount: 1 ¾" flat mounting surface required.
(Using L Bracket)

INSIDE MOUNT DEDUCTIONS

IB Deduction (Width): ¼"
 IB Deduction (Height): ½"

DISTANCE FROM THE WALL TO THE BACK OF THE TRACK (CLEARANCE)

	3-CHANNEL TRACK	4-CHANNEL TRACK	5-CHANNEL TRACK
Standard Bracket (2 7/8")	1 ¾"	1 ¼"	¾"
Large Bracket (4 ¼")	2 ½"	2 ¾"	1 7/8"

Adding an extension bracket will provide an extra 2 7/8" of clearance from the wall.

Add the track depth to the clearance to calculate the total projection into the room.

SHADE PRICING | Group A – C

Includes Standard Roman and Waterfall Shades.

WIDTH

PRICE GROUP A Pudong	LENGTH	24"	30"	36"	42"	48"	60"	72"	84"	96"
		36"	\$140	\$145	\$175	\$195	\$216	\$265	\$298	\$346
48"	\$160	\$183	\$206	\$233	\$256	\$318	\$355	\$415	\$457	
54"	\$171	\$206	\$222	\$248	\$279	\$345	\$391	\$448	\$498	
60"	\$180	\$214	\$240	\$265	\$291	\$367	\$429	\$480	\$539	
66"	\$189	\$222	\$256	\$283	\$313	\$418	\$460	\$529	\$595	
72"	\$199	\$235	\$272	\$302	\$332	\$437	\$485	\$580	\$650	
78"	\$212	\$250	\$289	\$325	\$361	\$464	\$525	\$614	\$691	
84"	\$223	\$265	\$306	\$346	\$391	\$491	\$553	\$650	\$740	
96"	\$244	\$292	\$340	\$384	\$429	\$559	\$639	\$744	\$847	
108"	\$275	\$328	\$382	\$432	\$481	\$628	\$718	\$837	\$952	

PRICE GROUP B Cala Malvern Osaka	LENGTH	24"	30"	36"	42"	48"	60"	72"	84"	96"
		36"	\$169	\$187	\$219	\$237	\$256	\$298	\$339	\$397
48"	\$205	\$235	\$265	\$291	\$317	\$360	\$406	\$480	\$561	
54"	\$213	\$248	\$282	\$311	\$339	\$389	\$439	\$521	\$602	
60"	\$223	\$261	\$298	\$330	\$360	\$418	\$473	\$561	\$643	
66"	\$235	\$276	\$316	\$349	\$383	\$446	\$508	\$598	\$682	
72"	\$247	\$290	\$333	\$369	\$406	\$473	\$543	\$636	\$721	
78"	\$257	\$304	\$351	\$390	\$429	\$503	\$577	\$672	\$763	
84"	\$268	\$318	\$367	\$409	\$451	\$532	\$611	\$708	\$804	
96"	\$292	\$362	\$401	\$449	\$496	\$614	\$709	\$817	\$921	
108"	\$328	\$390	\$450	\$504	\$556	\$690	\$797	\$919	\$1,034	

PRICE GROUP C Metro Terra Umbria	LENGTH	24"	30"	36"	42"	48"	60"	72"	84"	96"
		36"	\$196	\$222	\$250	\$266	\$298	\$369	\$431	\$526
48"	\$217	\$252	\$287	\$310	\$332	\$428	\$499	\$604	\$714	
54"	\$231	\$270	\$309	\$334	\$359	\$452	\$547	\$658	\$754	
60"	\$247	\$287	\$327	\$356	\$391	\$492	\$577	\$691	\$811	
66"	\$262	\$304	\$346	\$376	\$420	\$532	\$626	\$747	\$868	
72"	\$275	\$320	\$365	\$397	\$443	\$578	\$680	\$810	\$938	
78"	\$290	\$338	\$386	\$428	\$481	\$612	\$719	\$857	\$995	
84"	\$303	\$354	\$406	\$458	\$510	\$645	\$758	\$902	\$1,049	
96"	\$330	\$388	\$444	\$501	\$568	\$733	\$872	\$1,024	\$1,179	
108"	\$372	\$437	\$499	\$564	\$639	\$825	\$980	\$1,151	\$1,326	

SHADE PRICING | Group D – F

Includes Standard Roman and Waterfall Shades.

WIDTH

PRICE GROUP D Antilles Montana Nantucket Parchment Portland Sonoma Tortola	LENGTH	24"	30"	36"	42"	48"	60"	72"	84"	96"
		36"	\$228	\$240	\$270	\$289	\$306	\$389	\$455	\$552
48"	\$237	\$269	\$312	\$337	\$361	\$458	\$538	\$647	\$757	
54"	\$252	\$298	\$344	\$366	\$388	\$491	\$578	\$694	\$812	
60"	\$266	\$321	\$363	\$394	\$414	\$524	\$619	\$742	\$866	
66"	\$282	\$334	\$386	\$413	\$441	\$598	\$688	\$811	\$944	
72"	\$298	\$346	\$395	\$432	\$469	\$629	\$740	\$880	\$1,020	
78"	\$310	\$363	\$416	\$494	\$510	\$664	\$782	\$930	\$1,079	
84"	\$327	\$382	\$437	\$522	\$550	\$700	\$824	\$977	\$1,138	
96"	\$359	\$421	\$481	\$528	\$605	\$810	\$952	\$1,131	\$1,309	
108"	\$403	\$473	\$542	\$595	\$680	\$910	\$1,072	\$1,273	\$1,472	

PRICE GROUP E Como Selene	LENGTH	24"	30"	36"	42"	48"	60"	72"	84"	96"
		36"	\$251	\$264	\$297	\$318	\$337	\$428	\$500	\$607
48"	\$261	\$296	\$343	\$370	\$397	\$504	\$591	\$712	\$833	
54"	\$278	\$328	\$378	\$402	\$427	\$540	\$636	\$764	\$893	
60"	\$293	\$354	\$400	\$433	\$455	\$576	\$681	\$816	\$953	
66"	\$310	\$368	\$424	\$454	\$485	\$658	\$757	\$892	\$1,039	
72"	\$328	\$381	\$435	\$476	\$515	\$692	\$814	\$968	\$1,122	
78"	\$341	\$400	\$458	\$544	\$560	\$730	\$860	\$1,023	\$1,187	
84"	\$360	\$420	\$481	\$574	\$605	\$770	\$906	\$1,075	\$1,252	
96"	\$395	\$463	\$530	\$581	\$666	\$891	\$1,048	\$1,244	\$1,440	
108"	\$444	\$521	\$596	\$654	\$748	\$1,001	\$1,179	\$1,400	\$1,620	

PRICE GROUP F Soft Jute	LENGTH	24"	30"	36"	42"	48"	60"	72"	84"	96"
		36"	\$294	\$333	\$375	\$400	\$447	\$554	\$647	\$789
48"	\$326	\$379	\$431	\$465	\$498	\$642	\$749	\$906	\$1,071	
54"	\$347	\$405	\$463	\$501	\$538	\$678	\$820	\$987	\$1,131	
60"	\$370	\$431	\$491	\$535	\$587	\$738	\$866	\$1,036	\$1,217	
66"	\$393	\$456	\$519	\$564	\$629	\$798	\$940	\$1,120	\$1,302	
72"	\$412	\$480	\$547	\$596	\$664	\$868	\$1,020	\$1,215	\$1,408	
78"	\$435	\$507	\$578	\$642	\$722	\$919	\$1,078	\$1,285	\$1,492	
84"	\$454	\$531	\$608	\$687	\$764	\$968	\$1,138	\$1,353	\$1,574	
96"	\$494	\$582	\$666	\$752	\$852	\$1,099	\$1,308	\$1,536	\$1,769	
108"	\$557	\$656	\$749	\$847	\$959	\$1,238	\$1,471	\$1,727	\$1,990	

SHADE SURCHARGE OPTION PRICING

Add the surcharge below to the retail price of the basic shade.

		WIDTH									
		24"	30"	36"	42"	48"	60"	72"	84"	96"	
PRIVACY LINER Privacy Beige Privacy Black Privacy Gray Privacy Soft White Privacy Liners are the same color on both sides	LENGTH	36"	\$28	\$36	\$42	\$49	\$57	\$70	\$85	\$99	\$114
		48"	\$37	\$46	\$55	\$63	\$72	\$91	\$109	\$127	\$146
		54"	\$40	\$50	\$60	\$70	\$81	\$101	\$121	\$141	\$161
		60"	\$45	\$56	\$67	\$78	\$89	\$111	\$134	\$156	\$178
		66"	\$49	\$60	\$72	\$85	\$97	\$121	\$146	\$169	\$194
		72"	\$52	\$66	\$79	\$92	\$105	\$131	\$157	\$184	\$210
		78"	\$57	\$70	\$85	\$99	\$114	\$141	\$169	\$198	\$226
		84"	\$60	\$76	\$91	\$106	\$121	\$151	\$181	\$211	\$243
		96"	\$69	\$86	\$104	\$120	\$137	\$171	\$206	\$240	\$275
		108"	\$77	\$96	\$115	\$135	\$154	\$191	\$230	\$268	\$307

		WIDTH									
		24"	30"	36"	42"	48"	60"	72"	84"	96"	
BLACK-OUT LINER Black-Out Beige Black-Out White Black-Out Liners are off-white to the street	LENGTH	36"	\$30	\$37	\$45	\$52	\$59	\$75	\$89	\$104	\$119
		48"	\$38	\$48	\$57	\$67	\$77	\$96	\$115	\$134	\$152
		54"	\$42	\$53	\$63	\$75	\$85	\$106	\$127	\$148	\$170
		60"	\$47	\$58	\$70	\$81	\$93	\$117	\$140	\$164	\$187
		66"	\$51	\$63	\$77	\$89	\$102	\$127	\$152	\$178	\$204
		72"	\$56	\$69	\$82	\$97	\$110	\$138	\$166	\$194	\$220
		78"	\$59	\$75	\$89	\$104	\$119	\$148	\$178	\$208	\$238
		84"	\$63	\$80	\$96	\$111	\$127	\$159	\$191	\$223	\$255
		96"	\$72	\$90	\$108	\$126	\$145	\$180	\$217	\$253	\$288
		108"	\$80	\$101	\$121	\$141	\$161	\$201	\$242	\$283	\$323

TOP DOWN BOTTOM UP: **\$47**

HOBBLED STYLE: **30%**

TWIN SHADE: **\$126 plus liner surcharge**

CORDLESS SHADE:
 UP TO 42" width: **\$147**
 ABOVE 42" width: **\$194**

STAINLESS STEEL CHAIN: **\$30**

CLUTCH SYSTEM (width)

24"	30"	36"	42"	48"	60"	72"	84"	96"
\$95	\$110	\$126	\$137	\$142	\$147	\$158	\$168	\$179

CUT OUTS: **\$32 per cut out**

2-ON-1 HEAD RAIL: **\$42**. Price as individual shades and add surcharge.

3-ON-1 HEAD RAIL: **\$53**. Price as individual shades and add surcharge.

FABRIC VALANCE RETURNS: **\$32**

OPTIONAL LINED VALANCE: **\$16**

SHADE SURCHARGE OPTION PRICING

Add the surcharge below to the retail price of the basic shade.

WIDTH

NARROW EDGE BINDING	LENGTH	24"	30"	36"	42"	48"	60"	72"	84"	96"
		36"	\$31	\$32	\$35	\$36	\$38	\$41	\$45	\$48
Beige	48"	\$38	\$39	\$41	\$42	\$45	\$48	\$51	\$55	\$58
Black	54"	\$41	\$42	\$45	\$46	\$48	\$51	\$55	\$58	\$61
Chocolate	60"	\$45	\$46	\$48	\$49	\$51	\$55	\$58	\$61	\$65
Cream	66"	\$48	\$49	\$51	\$52	\$55	\$58	\$61	\$65	\$68
Desert Sand	72"	\$51	\$52	\$55	\$56	\$58	\$61	\$65	\$68	\$71
Gray	78"	\$55	\$56	\$58	\$59	\$61	\$65	\$68	\$71	\$75
Mocha	84"	\$58	\$59	\$61	\$63	\$65	\$68	\$71	\$75	\$78
Natural	96"	\$65	\$67	\$68	\$70	\$71	\$75	\$78	\$81	\$85
Pecan	108"	\$71	\$73	\$75	\$77	\$78	\$81	\$85	\$88	\$92
White										

WIDE EDGE BINDING	LENGTH	24"	30"	36"	42"	48"	60"	72"	84"	96"
		36"	\$40	\$42	\$45	\$47	\$49	\$53	\$58	\$62
Beige	48"	\$49	\$51	\$53	\$56	\$58	\$62	\$67	\$71	\$76
Black	54"	\$53	\$56	\$58	\$60	\$62	\$67	\$71	\$76	\$80
Chocolate	60"	\$58	\$60	\$62	\$65	\$67	\$71	\$76	\$80	\$85
Cream	66"	\$62	\$65	\$67	\$69	\$71	\$76	\$80	\$85	\$89
Desert Sand	72"	\$67	\$69	\$71	\$73	\$76	\$80	\$85	\$89	\$93
Gray	78"	\$71	\$73	\$76	\$78	\$80	\$85	\$89	\$93	\$98
Mocha	84"	\$76	\$78	\$80	\$82	\$85	\$89	\$93	\$98	\$102
Natural	96"	\$85	\$87	\$89	\$91	\$93	\$98	\$102	\$107	\$111
Pecan	108"	\$93	\$96	\$98	\$100	\$102	\$107	\$111	\$116	\$120
White										

WAND CONTROL SHADES

WAND CONTROL MOTOR: **\$221 (includes Wand)**

* USB CHARGER FOR WAND MOTOR: **\$53**

REMOTE CONTROL SHADES

REMOTE CONTROL MOTOR: **\$389**

* STANDARD CHARGER FOR RC MOTOR: **\$53**

* SOLAR CHARGER FOR RC MOTOR: **\$110**

SINGLE-CHANNEL REMOTE: **\$58**

MULTI-CHANNEL REMOTE: **\$74**

SINGLE-CHANNEL SWITCH: **\$103**

MULTI-CHANNEL SWITCH: **\$131**

CONNECTOR MOTOR HUB: **\$425**

* Chargers are not included with motorized wand or remote control shades; please identify desired quantity when placing order.



Wand Control Colors:
White, Beige, Gray, Bronze and Black
(available in 2, 3, 4 and 5 ft lengths)

FOLDING DOOR PRICING – ONE WAY OPENING

All tracks and valance boards over 100" wide will be spliced to avoid oversize freight charges.

5% FULLNESS		WIDTH						
PRICE GROUP A Pudong	LENGTH	48"	60"	72"	84"	96"	120"	Per extra 12" up to 192"
		48"	\$311	\$367	\$420	\$485	\$550	\$673
60"		\$347	\$411	\$472	\$545	\$617	\$757	\$70
72"		\$383	\$454	\$523	\$605	\$685	\$842	\$78
84"		\$419	\$498	\$575	\$664	\$753	\$926	\$87
96"		\$455	\$542	\$627	\$724	\$820	\$1,011	\$96
Valance		\$93	\$96	\$123	\$125	\$155	\$193	\$13

5% FULLNESS		WIDTH						
PRICE GROUP B Cala Malvern Osaka	LENGTH	48"	60"	72"	84"	96"	120"	Per extra 12" up to 192"
		48"	\$331	\$392	\$450	\$520	\$590	\$723
60"		\$372	\$442	\$509	\$588	\$667	\$819	\$77
72"		\$413	\$492	\$568	\$657	\$744	\$916	\$86
84"		\$454	\$542	\$627	\$725	\$822	\$1,013	\$95
96"		\$495	\$592	\$686	\$793	\$899	\$1,110	\$106
Valance		\$103	\$108	\$136	\$140	\$174	\$218	\$16

5% FULLNESS		WIDTH						
PRICE GROUP C Metro Umbria	LENGTH	48"	60"	72"	84"	96"	120"	Per extra 12" up to 192"
		48"	\$365	\$434	\$501	\$579	\$658	\$807
60"		\$414	\$495	\$572	\$663	\$752	\$926	\$86
72"		\$464	\$555	\$644	\$746	\$846	\$1,044	\$99
84"		\$513	\$616	\$716	\$829	\$941	\$1,162	\$110
96"		\$563	\$677	\$788	\$912	\$1,035	\$1,280	\$123
Valance		\$120	\$127	\$158	\$165	\$205	\$243	\$18

20% FULLNESS: **Add 20%**

BLACK-OUT LINER: **Add 40%**

SPLIT DRAW (CENTER-OPENING): **\$128**

NET FREIGHT SURCHARGE: **\$30**

PRIVACY LINER: **Add 30%**

SLIDING PANEL PRICING

All tracks and valance boards over 100" wide will be spliced to avoid oversize freight charges.

WIDTH

PRICE GROUP A Pudong	LENGTH	60"	72"	84"	96"	108"	120"	132"	144"
		60"	\$537	\$604	\$677	\$767	\$834	\$907	\$979
	72"	\$581	\$656	\$735	\$835	\$909	\$989	\$1,071	\$1,141
	84"	\$625	\$707	\$794	\$903	\$985	\$1,071	\$1,163	\$1,240
	96"	\$670	\$758	\$852	\$972	\$1,060	\$1,153	\$1,254	\$1,339
Valance		\$39	\$46	\$54	\$61	\$69	\$77	\$84	\$92

PRICE GROUP B Cala Malvern Osaka	LENGTH	60"	72"	84"	96"	108"	120"	132"	144"
		60"	\$549	\$618	\$694	\$785	\$855	\$930	\$1,004
	72"	\$595	\$672	\$755	\$857	\$934	\$1,017	\$1,101	\$1,174
	84"	\$642	\$727	\$816	\$929	\$1,014	\$1,104	\$1,198	\$1,278
	96"	\$689	\$781	\$878	\$1,002	\$1,093	\$1,190	\$1,295	\$1,382
Valance		\$40	\$48	\$57	\$64	\$72	\$81	\$88	\$97

PRICE GROUP C Metro Terra Umbria	LENGTH	60"	72"	84"	96"	108"	120"	132"	144"
		60"	\$559	\$631	\$708	\$802	\$874	\$951	\$1,027
	72"	\$608	\$687	\$772	\$877	\$957	\$1,041	\$1,128	\$1,203
	84"	\$657	\$744	\$836	\$953	\$1,040	\$1,132	\$1,229	\$1,312
	96"	\$706	\$800	\$901	\$1,028	\$1,123	\$1,223	\$1,330	\$1,421
Valance		\$42	\$50	\$59	\$67	\$76	\$84	\$92	\$101

PRICE GROUP D Antilles Montana Nantucket Parchment Portland Sonoma Tortola	LENGTH	60"	72"	84"	96"	108"	120"	132"	144"
		60"	\$595	\$673	\$756	\$858	\$936	\$1,020	\$1,102
	72"	\$651	\$738	\$830	\$945	\$1,032	\$1,124	\$1,218	\$1,301
	84"	\$707	\$803	\$904	\$1,031	\$1,127	\$1,229	\$1,334	\$1,426
	96"	\$763	\$868	\$978	\$1,118	\$1,223	\$1,333	\$1,451	\$1,551
Valance		\$47	\$57	\$66	\$76	\$85	\$95	\$104	\$113

PRICE GROUP E Como Selene	LENGTH	60"	72"	84"	96"	108"	120"	132"	144"
		60"	\$671	\$759	\$853	\$968	\$1,056	\$1,150	\$1,243
	72"	\$734	\$832	\$937	\$1,066	\$1,164	\$1,268	\$1,374	\$1,468
	84"	\$798	\$906	\$1,020	\$1,163	\$1,272	\$1,386	\$1,505	\$1,609
	96"	\$861	\$979	\$1,103	\$1,261	\$1,379	\$1,504	\$1,636	\$1,750
Valance		\$53	\$64	\$75	\$85	\$96	\$107	\$117	\$128

PRICE GROUP F Soft Jute	LENGTH	60"	72"	84"	96"	108"	120"	132"	144"
		60"	\$906	\$1,025	\$1,152	\$1,307	\$1,426	\$1,553	\$1,678
	72"	\$992	\$1,124	\$1,264	\$1,439	\$1,571	\$1,712	\$1,855	\$1,981
	84"	\$1,077	\$1,223	\$1,377	\$1,571	\$1,717	\$1,871	\$2,032	\$2,172
	96"	\$1,162	\$1,322	\$1,489	\$1,703	\$1,862	\$2,030	\$2,209	\$2,362
Valance		\$72	\$86	\$101	\$115	\$130	\$144	\$159	\$173

PRIVACY LINER: **Add 30%**

WIDE EDGE BINDING: **\$184**

BLACK-OUT LINER: **Add 40%**

NET FREIGHT SURCHARGE: **\$30**

PRO DESIGN NATURAL WOVEN WARRANTY

WHAT IS COVERED BY THIS WARRANTY?

This natural woven shade is warranted against defects in materials and workmanship, provided that:

1. The product was installed according to the product instructions.
2. Pro Design recommendations were followed regarding limitations and specifications of the product.

Pro Design reserves the right to determine if your shade warrants a repair or partial replacement of any parts. If necessary, Pro Design will replace your shade with a new shade of equal or superior value. This shall be your sole remedy under this warranty.

All motors, remote controls and wand motors are warranted for a period of five years from the date of purchase.

WHO IS COVERED BY THIS WARRANTY?

This warranty applies only to the original retail purchaser with proof of purchase in the USA.

WHAT IS NOT COVERED BY THIS WARRANTY?

Your Pro Design natural woven shade is made from natural materials, which will show natural variations in color, texture and weave. They may also show some fading and discoloration over time, or cracking, twisting, bowing or stretching and shrinkage due to exposure to direct sunlight or excessive moisture. These are not considered defects for the purposes of this warranty.

This warranty does not cover the removal or installation of original or replacement shades. This warranty does not cover damage or defects caused by, or resulting from improper maintenance, neglect or improper use, wear and tear, abuse, neglect, accidents, alteration, commercial use, installation, removal or reinstallation or exposure to excessive moisture.

Failure to follow the proper installation, charging and use instructions will invalidate the warranty for motors, remotes and wand motors.

YOUR RIGHTS UNDER STATE LAW

This warranty gives you specific legal rights. You may also have other rights which may vary from State to State. In no event shall Pro Design be liable for incidental or consequential damages or for any other direct or indirect damage, loss, cost, expense or fee. Some states do not allow the exclusion or limitation of incidental or consequential damages, so the above limitation or exclusion may not apply to you. This warranty is exclusive and in lieu of all other obligations, liabilities or warranties.

WALDEN
SELECT